

# OUTLANDER RENEGADE

**ACCESSORIES  
RIDING GEAR  
GENUINE PARTS**  
INTERNATIONAL VERSION



2018

**can-am**





**ENHANCE & EXTEND YOUR OFF-ROAD EXPERIENCE  
WITH ACCESSORIES BUILT BY CAN-AM FOR CAN-AM.**

*Wherever you're going,  
and whatever you're doing,  
Can-Am Off-Road accessories  
can help get you there  
and get it done – faster  
and more efficiently.  
High-quality, innovative  
accessories that work right,  
fit right and feel right because  
they're developed or approved  
by Can-Am for Can-Am.*

**QUALITY FIRST.**

The very best off-road accessories have to begin somewhere. At Can-Am, it all starts with our unwavering commitment to innovation, quality and seamless integration. It goes into everything we do, and everything we make; that's why we excel. High-performance engineering drives our race for perfection, quality steers it, and the result is Can-Am off-road customization that meets the very highest of standards. Yours.

**RUGGED RELIABILITY.**

Countless years of expertise and experience have allowed Can-Am to create off-road accessories without equal. Because they're created in parallel with the vehicles they're designed for, they come with an extra measure of confidence. Our guarantee. Genuine Can-Am accessories installed by you or an authorized dealer are covered for two entire years. Rely on it!

**STYLE & VISION.**

You get far more out of your Can-Am off-road vehicle when you customize it with genuine top-quality Can-Am accessories. But we've also gone the extra mile when it comes to design – so choosing Can-Am accessories means you always enjoy the very latest look – one that matches both your ride and your style.

# ACCESSORIES RIDING GEAR GENUINE PARTS

# OUTLANDER RENEGADE



ALWAYS  
CHECK OUT THE  
COMPATIBILITY GUIDE  
P.8-9 BEFORE  
YOU CUSTOMIZE

## ATV ACCESSORIES

## TIRES & RIMS

## SPORTSWEAR & RIDING GEAR

## PARTS & MAINTENANCE

- 8 COMPATIBILITY GUIDE
- 10 CARGO & STORAGE
- 17 WINDSHIELDS
- 19 HANDLEBARS & MIRRORS
- 20 SEAT KITS
- 21 RACKS & HOLDERS
- 24 SKID PLATES
- 28 BUMPERS & GUARDS
- 31 LIGHTS & ELECTRICAL
- 34 WINCHES
- 37 HITCHES
- 38 PERFORMANCE
- 42 COVERS, DECALS & ADD-ONS
- 43 APACHE TRACK SYSTEMS
- 46 PLOWS
- 47 ALPINE FLEX PLOWS
- 49 ALPINE SUPER-DUTY STEEL PLOWS
- 52 OUTLANDER 6X6 ACCESSORIES

- 55 TIRES
- 56 RIMS

- 59 CAN-AM SPORTSWEAR
- 61 JERSEYS
- 62 HELMETS
- 64 GOGGLES
- 64 GLOVES
- 64 JUNIOR
- 65 BAGS
- 65 SIZING CHART

- 67 GENUINE PARTS
- 68 OILS & MAINTENANCE

## GOING GLOBAL

This catalog, global in nature, shares BRP's full parts, accessories and clothing product offering. Some products may not be available in your country, due to different climates, local certifications and/or legal requirements. Contact your BRP dealer for local specifics.

Visit [instructions.brp.com](http://instructions.brp.com) for BRP accessories instruction sheets. You will find complete installation instructions, part number lists and service kits for repair and maintenance.



## CAN-AM OFFROAD.COM



Check out our videos to learn more about our new innovative riding gear and accessories.



Explore our interactive online catalog. Instantly explore products, videos, large format images and share with friends!



Learn about and purchase XPS oils and lubricants.

## BRP LIMITED WARRANTY\*

FOR NEW PARTS, ACCESSORIES AND RIDING GEAR.

2 YEAR LIMITED WARRANTY\*\*

4 YEARS LIMITED WARRANTY\*\*

AFTERMARKET PRODUCTS SOLD THROUGH BRP<sup>1</sup>  
RIDING GEAR

HELMETS

© 2017 Bombardier Recreational Products Inc. (BRP). All rights reserved. ®, ™ and the BRP logo are trademarks of BRP or its affiliates. CARLISLE is a trademark of Carlisle Companies. CHAMUDE and HIPORA are registered trademarks of Kolon Industries, Inc. CLARINO is a trademark of Kuraray Co. Ltd. COOLMAX and THERMOLITE are registered trademarks of INVISTA for durable fabrics. DRIRELEASE is a registered trademark of Optimer Inc. FOX is a registered trademark of Fox Racing Canada. GARMIN and MONTANA are registered trademarks of Garmin Ltd. iPod is a registered trademark of Apple Inc. KOLPIN, GUN BOOT and IMPACT are registered trademarks of Kolpin Powersports Inc. KYB is a registered trademark of Kayaba. MicroSD is a registered trademark of SD Card Association. Mud Lite XTR and SS312 are trademarks of ITP Tires. NEXT G-1 VISTA is a trademark of Next Camo, LLC. NGK is a registered trademark of NGK Spark Plugs, Ltd. PRIMALOFT GOLD and PRIMALOFT BLACK are registered trademarks of Albany International Corp. SUPERWINCH and S SUPERWINCH (design) are registered trademarks of Superwinch LLC. TEFLON, TEFLON HT and KEVLAR are trademarks of E.I. DuPont de Nemours & Co. TWINAIR is a trademark of Twin Air USA. UNI is a trademark of UNIFILTER Inc. VELCRO is a registered trademark of Velcro Industries. WARN is a trademark of Warn Industries Inc. YUASA is a registered trademark of YUASA Batteries Inc. ZILLA and BIGHORN 2.0 are trademarks of Maxxis. SCOTT is a trademark of Scott Sports SA. The following trademarks are the property of their respective owners: BLUETOOTH, CREE, DURO, DWT, HELLA, ITP, KENDA, MOSSY OAK, RAM, SUR LAST, VISION, XPS and YOSHIMURA. DRAGONFIRE is a trademark of KRANSCO. Baja Designs is a registered trademark of Baja Designs Inc. S3 POWERSPORTS is a trademark of S3 Power Sports LLC. Some models depicted herein may include optional equipment. Prices, if shown, are based on Manufacturer Suggested Retail Prices. Dealers may sell for a different price. For Canada & US, taxes are not included. Depending on location, products are distributed by BRP US Inc., Bombardier Recreational Products Inc., BRP European Distribution SA, BRP Finland Oy., BRP Australia Pty Ltd., BRP Brasil Motorsports LTDA, or BRP Comm. & Trade (Shanghai) Co Ltd. BRP reserves the right, at any time, to discontinue or change specifications, prices, designs, features, equipment without incurring obligation.

\*Use other than which the product is designed for will void the product lifetime warranty. <sup>1</sup>Applies only to BRP-made products or aftermarket products made by accredited BRP partners. Purchased at an authorized BRP dealership / distributor or on a BRP-authorized online store. Other exclusions may apply, see complete limited warranty or contact your Can-Am off-road authorized dealer. <sup>2</sup>Includes only BRP-approved aftermarket products and products made by currently accredited BRP partners. \*\*Unless otherwise stipulated or required by law. This limited warranty does not apply to factory installed accessories. This limited warranty does not apply on Evinrude parts and accessories. This limited warranty is effective as of March 1st, 2016.

# OUTLANDER ACCESSORIES BUILT FOR



**PUMP UP YOUR OUTLANDER**  
 ADD MUCH MORE MUSCLE, VERSATILITY, COMFORT, PROTECTION,  
 & RUGGED ABILITY WITH OUR SELECTED ACCESSORIES  
 BUILT FOR TAKING ON THE TOUGHEST JOBS.

- |   |       |
|---|-------|
| <b>1</b> LinQ LOW PROFILE BASKET                          | P. 16 |
| <b>2</b> LinQ BASE  | P. 15 |
| <b>3</b> LinQ HEAVY-DUTY BASKET                           | P. 16 |
| <b>4</b> XT FRONT BUMPER                                  | P. 29 |
| <b>5</b> EXTREME FRONT BUMPER                             | P. 29 |
| <b>6</b> XT REAR BUMPER                                   | P. 29 |
| <b>7</b> CAN-AM TERRA 35 WINCH BY SUPERWINCH <sup>†</sup> | P. 35 |

# OUTLANDER ACCESSORIES BUILT FOR THE



## PUMP UP YOUR OUTLANDER

EQUIP YOURSELF WITH ACCESSORIES BUILT FOR THE TRAIL AHEAD AND RIDE WITH MUCH MORE COMFORT, AGILITY, VISIBILITY, STYLE, & CARGO CAPACITY.

- |   |       |
|---|-------|
| <b>1</b> DELUXE FAIRING                 | P. 17 |
| <b>2</b> HIGH WINDSHIELD                | P. 17 |
| <b>3</b> LinQ 23 GAL (86 L) TRUNK BOX   | P. 13 |
| <b>4</b> LinQ 6" (15 CM) RACK EXTENSION | P. 21 |

8

**OUTLANDER RENEGADE**

# ATV ACCESSORY COMPATIBILITY GUIDE

## WE'VE MADE THINGS SUPER SIMPLE.

Determine your **MODEL YEAR**, find your **MODEL** and **ENGINE CONFIGURATION**, and that'll reveal your **PLATFORM CODE**.

This **PLATFORM CODE** will let you know at a glance if the accessory is compatible with your vehicle.

**EXAMPLE**

**FULL WRAP ALUMINUM MOUNTING KIT**

- Lightweight black die cast aluminum construction.
- Includes complete hardware.
- Handlebar wind deflectors sold separately.

→ Fits: **G2, G2L, G2S**  
715001378

MODEL YEAR	MODEL	ENGINE CONFIGURATION	PLATFORM CODE
2013	Outlander	400	G1
	Outlander	500, 650, 800, 1000	G2
	Outlander MAX	400	G1
	Outlander MAX	500, 650, 800, 1000	G2
	Renegade	500, 800, 1000	G2S

2014	Outlander	400	G1
	Outlander	500, 650, 800, 1000	G2
	Outlander MAX	400	G1
	Outlander MAX	500, 650, 800, 1000	G2
	Renegade	500, 800, 1000	G2S

**G1**

**G1S**

For G1 accessories, refer to your local dealer.

Some products shown may not be available or homologated in your country. Contact your BRP dealer for local details.

9

MODEL YEAR	MODEL	ENGINE CONFIGURATION	PLATFORM CODE
2015	Outlander L	450,500	G2L
	Outlander	500, 650, 800, 1000	G2
	Outlander L MAX	450, 500	G2L
	Outlander MAX	500, 650, 800, 1000	G2
	6x6	650, 1000	G2
	Renegade	500, 800, 1000	G2S

**G2**

2016	Outlander L	450, 570	G2L
	Outlander	570, 650, 850, 1000	G2
	Outlander L MAX	450, 570	G2L
	Outlander MAX	570, 650, 850, 1000	G2
	6x6	650, 1000	G2
	Renegade	570, 850, 1000	G2S

**G2L**

2017	Outlander	450, 570	G2L
	Outlander	650, 850, 1000	G2
	Outlander MAX	450, 570	G2L
	Outlander MAX	650, 850, 1000	G2
	6x6	650, 1000	G2
	Renegade	570, 850, 1000	G2S

**G2**

2018	Outlander	450, 570	G2L
	Outlander	650, 850, 1000	G2
	Outlander MAX	450, 570	G2L
	Outlander MAX	650, 850, 1000	G2
	6x6	650, 1000	G2
	Renegade	570, 850, 1000	G2S

**G2S**

For G1 accessories, refer to your local dealer.

10

# CARGO BOX O P T I O N S

**RUGGED LinQ CARGO BOXES INSTALL  
& REMOVE IN SECONDS!**

**RELIABLE & DURABLE, THEY'RE PERFECT  
FOR WORK & PLAY.**

## LinQ SYSTEM™ CARGO BOXES

**THERE'S A STORAGE SOLUTION THAT FITS YOU.**

**LinQ 8 GAL / 30L  
COOLER BOX**  
715002892 P.13

**KEEP THINGS COOLER, LONGER.**

**LinQ 11.5 GAL / 43L  
AUDIO CARGO BOX**  
715003018 P.14

**BRING YOUR  
GEAR & YOUR  
TUNES ALONG  
FOR THE RIDE.**

**LinQ 12 GAL / 45L**  
715003879 P.14

**LinQ 23 GAL / 86L**  
715002474 P.13

**LinQ 32 GAL / 124L**  
715001749 P.12  
715001747 P.12  
715001750 (EC) P.12  
715001748 (EC) P.12

**BRING ALL YOU NEED  
FOR THE RIDE, INCLUDING  
YOUR FAVORITE TUNES!**

**LinQ 11.5 GAL (43L)  
AUDIO CARGO BOX**

**CATCH THE  
VIDEO**

CAN-AMOFFROAD.COM

11

Some products shown may not be available or homologated in your country. Contact your BRP dealer for local details.

**OUTLANDER RENEGADE**

# LinQ 32 GAL (124L) TRUNK BOXES

### Seamless integration with vehicle

- Built from the design stage to specifically match your Can-Am vehicle.
- Totally cohesive design eliminates the need to modify your vehicle in any way\*.
- Rear tail light.

### Easy quick-attach installation

- Equipped with the LinQ System, the rear trunk box plugs in and out in seconds.
- Instantly transforms your vehicle to suit the need of the moment.

### Unparalleled storage

- 32 Gal (124L) load capacity with contiguous unobstructed space to maximize storage room and access to the trunk's interior.

### Built tough

- Made of injection-molded polyethylene, double walled in critical areas.

### Dust & weather proof

- The fully sealed lid protects your belongings from dust, moisture and the elements.



**LinQ SYSTEM**

### LinQ 32 GAL (124L) TRUNK BOX

- LinQ Retrofit Adaptor Plate (715001334) is required for G1 models.
- Trunk Box Panels available in many colors to match your vehicle (sold separately).
- LinQ Luggage Rack (715001734) is required for G2S.

**Fits: G2 (except MAX models & 6x6), G2S**  
715001747

**EUROPEAN VERSION (EC compliant)**  
• No rear tail light  
715001748



**LinQ SYSTEM**

### LinQ 32 GAL (124L) TRUNK BOX FOR OUTLANDER MAX

- Passenger comfort is ensured on active rides as well as longer recreational rides thanks to the ergonomically designed passenger padding comfort-fitted with a portion made of closed cell foam that won't absorb water.
- Very easy to embark even when driver is seated.
- Trunk Box Panels available in many colors to match your vehicle (sold separately).

**Fits: G2 (MAX models only)**  
715001749

**EUROPEAN VERSION (EC compliant)**  
• No rear tail light  
715001750

**ERGONOMIC PADDING MADE OF CLOSED CELL FOAM.**



### LinQ 32 GAL (124L) TRUNK BOX PANELS

- Color panels to match the 32 Gal (124L) LinQ Trunk Box to your vehicle.

**Fits: LinQ 32 Gal (124L) Trunk Boxes**

- 715001391 - Black
- 715001392 - Yellow
- 715001395 - Viper Red
- 715002481 - White
- 715002480 - Light Grey
- 715002984 - Octane Blue
- 715002985 - Manta Green
- 715002986 - Can-Am Red

**EUROPEAN VERSION (EC compliant)**

- No rear tail light
- 715001397 - Black
- 715001398 - Yellow
- 715002482 - Light Grey
- 715002483 - White



### CAMO DECALS FOR BLACK TRUNK BOX PANELS

- Camo pattern perfectly matches your camo vehicle.

**Fits: Black LinQ 32 Gal (124L) Trunk Box Panel**

- 715002975 - Mossy Oak Break-Up Country Camo
- 715001683 - Next G-1 Vista Camo



**LinQ SYSTEM**

### LinQ REPLACEMENT PART

715001707

\* WARNING: You should never accessorize your Can-Am off-road vehicle with accessories not approved by BRP because your vehicle may no longer meet certain safety and construction standards. This situation could increase the risk of severe injury or death and render your vehicle not legal for use.

**NOT SURE IF AN ACCESSORY FITS YOUR MODEL? CHECK OUT OUR ACCESSORY COMPATIBILITY GUIDE ON P.8-9**

Some products shown may not be available or homologated in your country. Contact your BRP dealer for local details.

**OUTLANDER RENEGADE**



### PREMIUM INSULATION KEEPS THINGS COOLER, LONGER!

**LinQ SYSTEM**

### LinQ 8 GAL (30L) COOLER BOX

- Installs without vehicle modification.
- LinQ mounted for easy-on, easy-off installation.
- Rotomolded construction provides exceptional rigidity and durability.
- Premium-quality foam insulation for optimal ice retention.
- Integrated, fully-removable compartment protects food.
- Weather-resistant, lockable.
- Convenient drain plug.
- LinQ Luggage Rack (715001734) is required for G2S.

**Fits: G2, G2S**  
715002892



**LinQ SYSTEM**

### LinQ 23 GAL (86L) TRUNK BOX

- Installs without vehicle modification.
- LinQ mounted for easy-on, easy-off installation.
- Lockable and weather-resistant.
- Holds cargo safely and securely while riding.
- Comfort pads for passenger.
- LinQ Base (715002350) is required for G2L.

**Fits: G2 (except 6x6), G2L, G2S**  
715002474





**WE'VE PACKED AN ENTIRE SOUND SYSTEM INTO OUR LinQ AUDIO CARGO BOX!**



**OUTLANDER RENEGADE**

**SOFT STORAGE BAG**

- 3-section bag.
- Transport gear in a weatherproof bag.
- 11.8 Gal (45L) capacity soft cargo bag designed with vehicle's rear or front rack and rack extensions in mind to maximize potential storage.
- LinQ Luggage Rack (715001734) is required for G2S.

**Fits: G2, G2L, G2S**

**715003759 • Black**

**715001935**

**Mossy Oak Break-Up Country Camo**



**PROTECTS YOUR GEAR. ORGANIZES YOUR STORAGE & MAXIMIZES VERSATILITY.**

**OUTLANDER RENEGADE**



**LinQ SYSTEM**

**LinQ 11.5 GAL (43L) AUDIO CARGO BOX**

- Delivers the best sound quality on the market to sweeten your ride courtesy of a built-in full range high efficiency amplifier.
- Mounts on/off easily to hold/carry cargo safely and securely.
- Automatic shut-off function protects your battery by turning the system off after 10 minutes of inactivity.
- Water-resistant speakers.
- The Bluetooth enabled receiver and 6.5" (16.5 cm) speakers are smartly concealed and integrated in the cover.
- Backlit control panel perfect for night riding.
- LinQ Base (715002350) is required for G2L.
- LinQ Luggage Rack (715001734) is required for G2S.

**Fits: G2 (front only for 6x6 & MAX models 2013-2014), G2L, G2S**

**715003018**



**LinQ SYSTEM**

**LinQ 12 GAL (45L) CARGO BOX**

- Installs without vehicle modification.
- LinQ mounted for easy-on, easy-off installation.
- Holds cargo safely and securely while riding.
- LinQ Base (715002350) is required for G2L.
- LinQ Luggage Rack (715001734) is required for G2S.

**Fits: G2 (front only for 6x6 & MAX models 2013-2014), G2L, G2S**

**715003879**



**STORAGE 2.6 GAL (10L) BAG**

- Roll-top dry bag for fully protecting your cargo from the elements.
- Fits in rear compartment of your vehicle.

**Fits all**

**269502121**



**LinQ SYSTEM**

**LinQ STORAGE BOX 2 GAL (7.5L)**

- Features easy quick-attach LinQ installation on Outlander front and rear racks.
- Also installable behind the driver seat on Outlander MAX.
- Fully sealed box provides additional storage for essential and valuable items.
- LinQ Luggage Rack (715001734) is required for G2S.

**Fits: G2, G2S**

**708200255**

**Fits: G2, G2L (G2 L MAX only behind the driver seat), G2S**

**708200408**



**LinQ SYSTEM**

**LinQ BASE**

- Made of polypropylene glass fiber.
- Allows you to install LinQ accessories.
- Sold in pack of 4.

**Fits: G2L**

**715002350**

**LinQ SYSTEM**

**LinQ DELUXE MODULAR BAG**

- Installs without vehicle modification.
- LinQ mounted for easy-on, easy-off installation.
- Tool-less installation and removal.
- Versatile, rugged and spacious.
- Ideal for carrying anything you need in any conditions.
- Weatherproof, scratch-resistant, with molded rubber bottom.
- Central compartment can be used alone on the rack.
- Removable bin.
- LinQ Luggage Rack (715001734) is required for G2S.

**Fits: G2 (front only for 6x6), G2S**

**12 Gal (44L) Bag**

**715001695**

**20 Gal (73L) Bag**

**715001694**



**CARGO BAG**

- Rugged all-purpose cargo bag with rain cover for additional protection against the elements.
- LinQ Luggage Rack (715001734) is required for G2S.

**Fits: G2, G2L, G2S**

**280000539 • Black**



**RAIN COVER FOR ADDITIONAL PROTECTION**





**LinQ SYSTEM MOUNTS STEEL BASKET IN SECONDS SO YOU CAN LOAD & GO QUICKER**



**OUTLANDER RENEGADE**



**LinQ SYSTEM**  
**LinQ HEAVY-DUTY BASKET**  
 • Made of high strength, low-alloy steel.  
 • Installs without vehicle modification.  
 • LinQ mount for easy-on, easy-off installation.  
 • Can be placed on both front and back racks of vehicle.  
 • LinQ Base (715002350) is required for G2L.  
 • LinQ Luggage Rack (715001734) is required for G2S.  
**Fits: G2, G2L (front only for MAX models), G2S**  
**715001215**



**LinQ SYSTEM**  
**LinQ LOW PROFILE BASKET**  
 • Low profile, open basket increases cargo space.  
 • Perfect for easy access to tools, rope, winch and plow accessories.  
 • Multiple bungee cord and tie-down anchor points.  
 • Made of impact-resistant injected polypropylene.  
 • LinQ Base (715002350) is required for G2L.  
**Fits: G2L (front only for MAX models)**  
**715003027**

**RENEGADE**



**REAR BAG FOR RENEGADE 4.5 GAL (17L)**  
 • Weatherproof, scratch-resistant, with a molded rubber bottom.  
 • Tool-less installation and removal.  
 • With 2 straps that go underneath the rack and click into the front of the bag.  
 • Requires Rear Aluminum Rack.  
**Fits: G2S**  
**715002391**

**OUTLANDER**

**CREATE YOUR ULTIMATE WIND PROTECTION IN 3 EASY STEPS**

**1 CHOOSE A DELUXE FAIRING COLOR**

**DELUXE FAIRING**

- Innovative, richly-featured wind protection.
- Quick tool-less removal once base brackets are mounted on handlebar.
- 2 cup holders.
- GPS-mounting-kit-ready.
- Optional mirrors and auxiliary lighting.
- Requires low, high or extra high windshield.
- Tapered Handlebar Adaptor Kit is required for vehicles with 1 1/8" (28 mm) tapered aluminum handlebars.

**Fits: G2 (except X mr & 6X6), G2L**

- 715000935 • Yellow
- 715001231 • Red
- 715001232 • Black
- 715002479 • Light Grey



**CAMO DECALS FOR BLACK DELUXE FAIRING**

- Camo pattern perfectly matches your camo vehicle.

**Fits: Deluxe Fairing**

- 715002976 Mossy Oak Break-Up Country Camo
- 715001684 Next G-1 Vista Camo

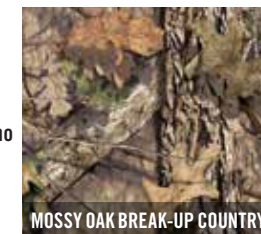

MOSSY OAK BREAK-UP COUNTRY

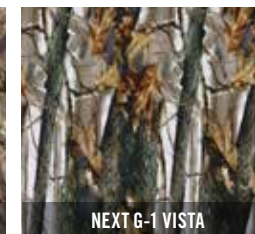

NEXT G-1 VISTA

**TAPERED HANDLEBAR ADAPTOR KIT**

- (Not illustrated)
- Required to install Deluxe Fairing on an Outlander X-TP and on any vehicle equipped with 1 1/8" (28 mm) tapered aluminum handlebars.

**Fits: Deluxe Fairing**  
**715002470**

**2 CHOOSE A DELUXE WINDSHIELD**



**LOW WINDSHIELD**

- 6" (15 cm) windshield allows you to keep your vehicle looking sporty while giving you some protection from the elements and the possibility of enjoying directional lighting.
- Tool-less installation and replacement.

**Fits: Deluxe Fairing**  
**715001227**



**HIGH WINDSHIELD**

- 11" (28 cm) high, for wind protection and winter applications.
- Tool-less installation and replacement.

**Fits: Deluxe Fairing**  
**715001211**



**EXTRA HIGH WINDSHIELD**

- 16" (41 cm) windshield provides the ultimate protection against the elements while touring.
- For wind protection and winter applications.
- Tool-less installation and replacement.

**Fits: Deluxe Fairing**  
**715000936**

**3 YOU MIGHT ALSO LIKE...**

**AUXILIARY WINDSHIELD LIGHTING**

- 2 premium LED spots for Deluxe Fairing for both increased output and directional lighting.
- 1,800 lumens.
- 2 10W LED Cree light kit.
- Long-range illumination up to 350' (107 m), drawing less than 1 amp per light.

**Fits: Deluxe Fairing**  
**715003115**



**DELUXE MIRROR KIT**

- Improved mounting system.
- Wide rear view.
- Perfect fit with your Deluxe Fairing and Deluxe Windshield.

**Fits: Deluxe Fairing**  
**715002353**





**DESIGN YOUR OWN DELUXE WIND PROTECTION SOLUTION SEE P. 17**

**OUTLANDER RENEGADE**

**PROVIDES EXCELLENT WIND PROTECTION**

**SPORT WINDSHIELD**

- Offers your Renegade wind protection without compromising its sporty look.
- Fits straight and tapered handlebars.
- Easy mounting system allows you to install it effortlessly.

**Fits: G2S (except X mr)**

- 715001212 - Yellow
- 715001429 - White
- 715001468 - Black



**HIGH WINDSHIELD KIT**

- Provides excellent wind protection.
- Fits straight and tapered handlebars.
- Easy mounting system allows you to install it effortlessly.

**Fits: G2, G2L, G2S (except X mr)**

- 715001937 - Yellow
- 715001938 - Black
- 715002061 - Red



**OUTLANDER RENEGADE**



**HANDLEBAR WIND DEFLECTORS**

- Rugged injected plastic construction with Can-Am logo.
- Include removable cap for air flow adjustment.
- Mounting kit sold separately.

**Fits: G2, G2L, G2S**

- 715000525 - Black / Yellow
- 715000537 - White / Black
- 715001706 - Black / Black
- 715000733 - Yellow / Black

- 715003811 - Can-Am Red / Black
- 715003812 - Manta Green / Black
- 715003813 - Orange / Black
- 715003814 - Octane Blue / Black



**PASSENGER WIND DEFLECTORS**

- These wind deflectors fit on the passenger handles and provide greater comfort while riding.
- Easy to install and remove.

**Fits: G2 and G2L (MAX models only)**

**715001669**

**FULL WRAP ALUMINUM MOUNTING KIT**

- Lightweight black die cast aluminum construction.
- Includes complete hardware.
- Handlebar wind deflectors sold separately.

**Fits: G2, G2L, G2S**

**715001378**



**SHORT ALUMINUM MOUNTING KIT**

- Lightweight black die cast aluminum construction.
- Includes complete hardware.
- Handlebar wind deflectors sold separately.

**Fits: G2, G2L, G2S**

**715001379**



**ALUMINUM TAPERED HANDLEBAR**

- 7/8"- 1 1/8" (22 mm - 28 mm) tapered handlebar made of 6061-T6 aluminum.
- Includes all hardware, center steering foam and cover.

**Fits: G2, G2L, G2S**

**715000550**

**MIRROR KIT FOR HANDLEBAR WIND DEFLECTORS**

- Do not fit with Full Wrap Aluminum Mounting Kit (715001378).
- Sold in pairs.

**Fits: Handlebar Wind Deflectors**

**860200080**



**XT HANDLEBAR PROTECTOR KIT**

- Not compatible with Mud Strap (715003053).

**Fits: G2, G2L**

**703100352 - Black**

**MIRRORS**

- True vision surface 5" x 3" (13 cm x 8 cm).
- Matte finish.
- Stem includes 3/8" (10 mm) thread.

**Left - 3/8" (10 mm)**

- Bracket (715000190) is required for installation on DS 450.
- Bracket not required for installation on Outlander and Renegade.

**709400406**

**Right - 3/8" (10 mm)**

- Bracket (715000190) required except for vehicles with right hand break.

**709400523**





**DRIVER BACKREST DELIVERS EXTRA SUPPORT SO YOU CAN COVER EXTRA MILES!**



**CATCH THE VIDEO**



CAN-AMOFFROAD.COM

**OUTLANDER**



**NEW DRIVER BACKREST**

- Provides the rider's back with that extra support that makes riding that extra mile way more comfortable.
- Adjusts horizontally to match the driver's height and preference.
- Mounts and locks in firmly onto the vehicle.

**Fits: G2**  
(except MAX models)  
715003940

**Fits: G2 and G2L**  
(MAX models only)  
715003942

**Fits: G2L**  
(except MAX models)  
715003941



**OUTLANDER MAX PASSENGER SEAT KIT**

- Perfect to replace used or damaged passenger seat.

**Fits: G2 2015 and up, G2L**  
(MAX models only)  
715002373

**Fits: G2 2013-2014 (MAX models only)**  
except with 400 engine  
715002032

**OUTLANDER RENEGADE**



**LinQ 4" (10 CM) RACK EXTENSION**

- Fits front or rear.
- Strong and durable.
- Helps keep cargo securely in place.
- Easy and tool-less installation thanks to the LinQ System.

**Fits: G2, G2S**  
715001711 - Silver  
715001665 - Black

- Anti-corrosion coating with durable powder coat finish.
- LinQ Luggage Rack (715001734) is required for G2S.



**LinQ 6" (15 CM) RACK EXTENSION**

- Fits front or rear.
- Strong and durable.
- Helps keep cargo securely in place.
- Easy and tool-less installation thanks to the LinQ System.

**Fits: G2, G2S**  
715001712 - Silver  
715001671 - Black

- Anti-corrosion coating with durable powder coat finish.
- LinQ Luggage Rack (715001734) is required for G2S.



**OUTLANDER**



**5" (13 CM) RACK EXTENSION**

- Fits front or rear.
- Made of carbon steel.
- Provides tie-down points to secure cargo on racks.
- Easy installation on tubular rack.
- Anti-corrosion coating with durable powder coat finish.

**Fits: G2L**  
715001913



**8" (20 CM) RACK EXTENSION**

- Fits front or rear.
- Made of carbon steel.
- Provides tie-down points to secure cargo on racks.
- Easy installation on tubular rack.
- Anti-corrosion coating with durable powder coat finish.

**Fits: G2L**  
715001914

**RENEGADE**



**LinQ LUGGAGE RACK**

- Bolt-on rack.
- Enables use of LinQ mounted accessories on the G2S.

**Fits: G2S**  
(except X mr models)  
715001734



**REAR ALUMINUM RACK**

- 30 lb (14 kg) capacity.
- Compact, lightweight aluminum construction.
- Engraved Can-Am logo.
- Stamped 5052 aluminum center plate.
- Easy to install.

**Fits: G2S**  
715001360

**OUTLANDER**



**LinQ GUN BOOT RACK**

- (Not illustrated)
- This lightweight Gun Boot Rack can be mounted on either side of your Outlander using the tool-less LinQ System.
  - For use with Gun Boot 6.0 Impact by Kolpin.

**Fits: G2 (except MAX, 6X6 & X mr 1000)**  
715002112 • Black  
**Fits: G2 (MAX & X mr 1000 models only)**  
715002113 • Black



715001919

**GUN BOOT RACK**

- Made of steel.
- Designed for the tubular rack.
- For use with Gun Boot 6.0 Impact by Kolpin.
- Can be mounted to either side of the vehicle.

**Fits: G2L (except MAX models)**  
715001918  
**Fits: G2L (MAX models only)**  
715001919

**GEAR GRIPS BY KOLPIN**

- Durable, flexible grips cushion and protect while providing a custom fit for a variety of items from 1" to 4" (2.5 cm to 10 cm) in diameter.
- Heavy-duty design for carrying bows, fishing poles, rakes, farm tools and more.
- Quick-release button opens grip quickly for easy access to gear.
- Heavy-duty base system built for the toughest adventures.
- Easy installation on tubular racks, extension racks, brackets or bumpers.
- Sold in pairs.

**Fits: G2L**  
715001421



**GUN BOOT 6.0 IMPACT<sup>+</sup> BY KOLPIN<sup>+</sup>**

- Extra room for pistol-grip-type weapons and small bipods.
- Easily fits firearms up to 51" (130 cm) in total length.
- Provides ample room for 2 3/8" (60 mm) scopes.
- Hatchback design allows easy access.
- Ergonomically designed handle and molded attachment points for sling.
- Snap-close cover with locking capability.
- Designed to accommodate left and right hand bolt-action rifles and shotguns.
- Includes removable, shock absorbing foam and nylon impact liner for superior interior protection.
- Requires appropriate mounting kit for installation.

**Fits: G2, G2L**  
715001419

**MULTI-FIT HOLDER**

- Open u-shaped bracket for carrying tools (shovel, axe) and hunting weapons (rifle, bow) that are safely secured, but easily accessible.
- Easy installation on tubular rack, extension racks, basket or bumpers.
- For G2 the LinQ Rack Extension is required.
- Sold in pairs.

**Fits: G2, G2L**  
Single  
715002354

**Fits: G2, G2L**  
Double  
715001945



**OUTLANDER RENEGADE**



**LinQ MOUNTED GEAR GRIPS BY KOLPIN**

- (Not illustrated)
- Same features as Gear Grip by Kolpin (715001421).
  - Make transporting your tools a snap by combining the Gear Grips with the LinQ System.
  - 360° orientation.
  - LinQ Luggage Rack (715001734) is required for G2S.

**Fits: G2, G2S**  
715001351



**LinQ TOOL HOLDER**

- Ultra-versatile tool holder.
- Convenient swivel-latch allows tools to be stored in any orientation.
- LinQ Luggage Rack (715001734) is required for G2S.
- Sold in pairs.

**Fits: G2, G2S**  
715003059



**OUTLANDER**



**ALUMINUM SKID PLATES**

Our Aluminum Plates are made with high strength 5052 H32 aluminum. A must-have for rugged terrain.

Offer your Outlander **THE FULL PROTECTION KIT** or **GET THEM INDIVIDUALLY**

Some products shown may not be available or homologated in your country. Contact your BRP dealer for local details.

**OUTLANDER**

FIND YOUR PLATFORM →

**ALUMINUM SKID PLATE PROTECTION KIT**

**INDIVIDUAL ALUMINUM SKID PLATES**

	G2 2016 & PRIOR (EXCEPT MAX MODELS)	G2 2017 & UP (EXCEPT MAX MODELS)	G2 2016 & PRIOR (MAX MODELS & OUTLANDER X MR 1000 ONLY)	G2 2017 & UP (MAX MODELS & OUTLANDER X MR 1000 ONLY)	G2L (EXCEPT MAX MODELS)	G2L (MAX MODELS ONLY)	G2 (6X6 ONLY)
<b>ALUMINUM SKID PLATE PROTECTION KIT</b>	715002137	715004197	715002138	715004198	715004199	715004200	
<b>1 A-ARM PROTECTORS</b> • 1/8" (3 mm) thick lightweight and durable design. • Add more protection to the CV joints and rubber boots. • Drain holes to release water, mud and debris. • Easy to install. • Replace stock plastic protectors. • Sold in pairs. • Except X mr models.	715001667	715001667	715001667	715001667	715001667	715001667	715001667
<b>2 FRONT SKID PLATE</b> • 3/16" (4.5 mm) thick and die-formed for strength and durability. • Use in conjunction with the central skid plate for full frame protection.	715000926	715000926	715000926	715000926	715001906	715001906	
<b>3 CENTRAL SKID PLATE</b> • 3/16" (4.5 mm) thick for durability and strength. • Drain holes to release water, mud and debris. • Allows access to oil drain plug. • Must be installed with front skid plate.	715002078	715002078	715002078	715002078	715002078	715002078	
<b>4 FOOTWELL PROTECTOR PLATES</b> • 1/8" (3 mm) thick lightweight and durable design. • Use in conjunction with the central skid plate. • Drain holes to release water, mud and debris. • Sold in pairs.	715001359	715001359	715001359	715001359	715001359	715001359	
<b>5 TRAILING ARM PROTECTORS</b> • 1/8" (3 mm) thick lightweight and durable design. • Replace stock plastic protectors. • Sold in pairs.	715001129	715003741	715001129	715003741	715003741	715003741	715001129 (2016 & prior) 715003741 (2017 & up)
<b>6 REAR DIFFERENTIAL PROTECTORS</b> • 1/8" (3 mm) thick lightweight and durable design. • Replace stock plastic protector.	715000920	715000920	715000920	715000920	715000920	715000920	
<b>7 REAR SKID PLATE</b> • 3/16" (4.5 mm) thick for durability and strength. • Must be installed with the central and front skid plates.	715002028	715002028	715002029	715002029	715002028	715002029	

RENEGADE

## ALUMINUM SKID PLATES

Our Aluminum Plates are made with high strength 5052 H32 aluminum. A must-have for rugged terrain.

Offer your Renegade  
**THE FULL PROTECTION KIT**

or  
**GET THEM INDIVIDUALLY**

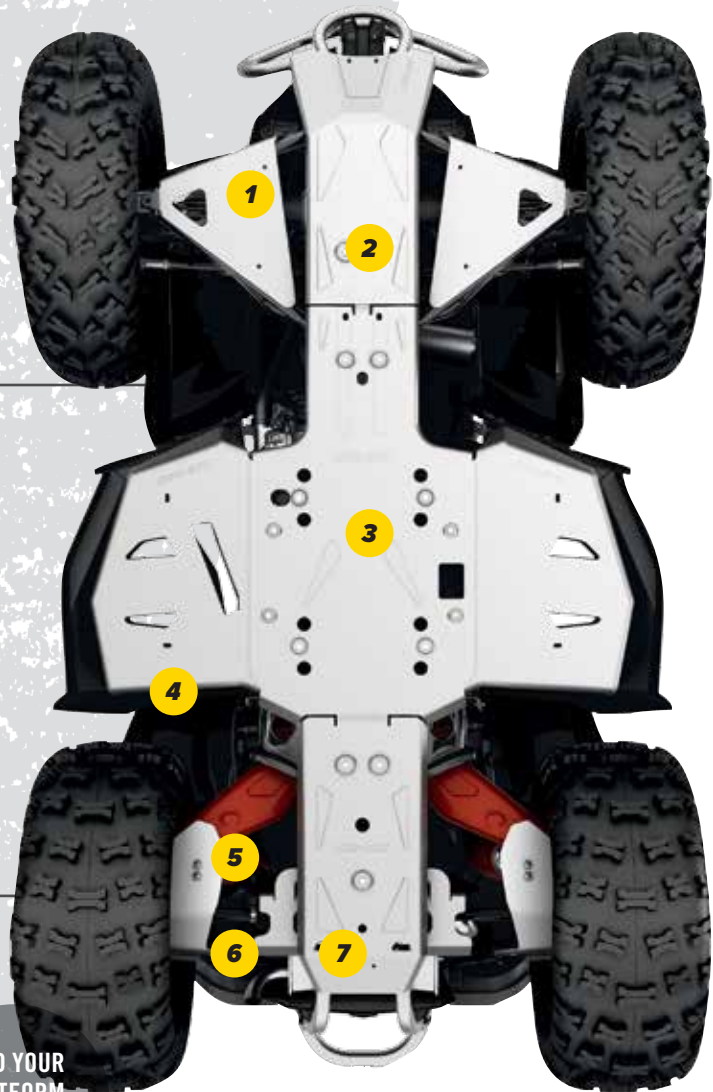

FIND YOUR PLATFORM



G2S 2016 & PRIOR

G2S 2017 & UP

### ALUMINUM SKID PLATE PROTECTION KIT

715002139

715004201

### INDIVIDUAL ALUMINUM SKID PLATES

<b>1 A-ARM PROTECTORS</b> • 1/8" (3 mm) thick lightweight and durable design. • Add more protection to the CV joints and rubber boots. • Drain holes to release water, mud and debris.	• Easy to install. • Replace stock plastic protectors. • Sold in pairs.	715001667	715001667
<b>2 FRONT SKID PLATE</b> • 3/16" (4.5 mm) thick and die-formed for strength and durability. • Recessed bolt holes.		715000925	715000925
<b>3 CENTRAL SKID PLATE</b> • 3/16" (4.5 mm) thick for durability and strength. • Drain holes to release water, mud and debris. • Allows access to oil drain plug.	• Standard on Renegade X xc. • Must be installed with Front Skid Plate.	715002078	715002078
<b>4 FOOTWELL PROTECTOR PLATES</b> • 1/8" (3 mm) thick lightweight and durable design. • Drain holes to release water, mud and debris.	• Use in conjunction with Central Skid Plate. • Sold in pairs.	715001359	715001359
<b>5 TRAILING ARM PROTECTORS</b> • 1/8" (3 mm) thick lightweight and durable design. • Replace stock plastic protectors.	• Sold in pairs.	715001129	715003741
<b>6 REAR DIFFERENTIAL PROTECTORS</b> • 1/8" (3 mm) thick lightweight and durable design. • Replace stock plastic protector.		715000920	715000920
<b>7 REAR SKID PLATE</b> • 3/16" (4.5 mm) thick for durability and strength. • Must be installed with the central and front skid plates.		715002028	715002028

Some products shown may not be available or homologated in your country. Contact your BRP dealer for local details.

OUTLANDER RENEGADE

## HMWPE SKID PLATES

Our Plastic Plates glide smoothly and silently over obstacles, offering great protection in rough terrain. Made of 1/4" (6 mm) thick abrasion-resistant thermoformed High Molecular Weight Polyethylene (HMWPE). Lighter than aluminum. Superior stress crack resistance. High impact strength.

Offer your Outlander & Renegade  
**THE FULL PROTECTION KIT**

or  
**GET THEM INDIVIDUALLY**

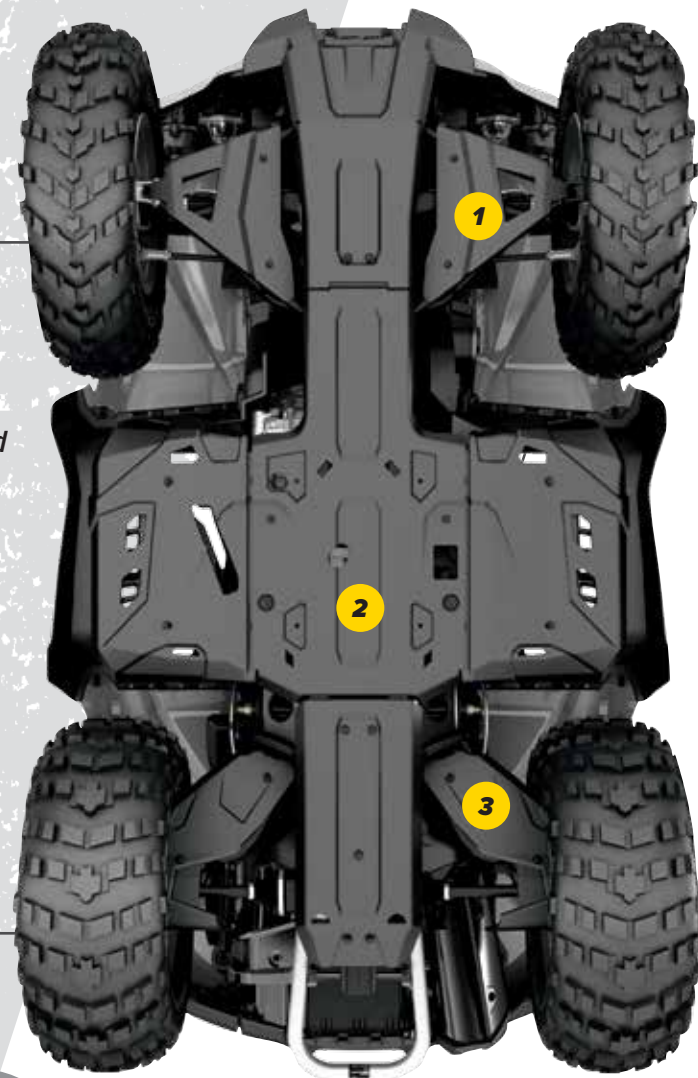

FIND YOUR PLATFORM



G2 2017 & UP

G2 2016 & PRIOR

G2 MAX 2017 & UP

G2 MAX 2016 & PRIOR

G2L

G2L MAX

G2S 2017 & UP

### HMWPE SKID PLATE PROTECTION KIT

715004209

715004214

715004210

715004215

715004211

715004212

715004213

### INDIVIDUAL HMWPE SKID PLATES

<b>1 A-ARM PROTECTORS</b> • Protect CV joints and rubber boots. • Include water and mud drainage holes.	• Sold in pairs.	715002924	715002924	715002924	715002924	715002924	715002924	715002924
<b>2 UNDERBELLY PLATES</b> • Include Front Skid Plate, Central Skid Plate, Footwell Protector Plates and Rear Skid Plate. • Allow access to oil drain plug.	• Include water and mud drainage holes.	715002926	715002926	715002927	715002927	715002928	715002929	715002974
<b>3 TRAILING ARM PROTECTORS</b> • Include water and mud drainage holes. • Sold in pairs.		715003466	715002925	715003466	715002925	715003466	715003466	715003466

### PLASTIC SKID PLATES

#### FRONT AND CENTRAL PLASTIC SKID PLATES

(Not illustrated)  
• Designed to protect frame and engine from rough terrain conditions.

• Standard on Outlander L DPS® and Outlander L MAX DPS.

715002374  
(STD only)



**KEEP YOUR VEHICLE & YOUR LIVESTOCK SAFE WITH FULL-PERIMETER PROTECTION. THINK OF IT AS RANCHING ARMOR.**

**OUTLANDER**

**COMPLETE RANCHER PROTECTION KIT**

(Not illustrated)  
Introducing a whole new level of surround protection for your ATV thanks to this Full Body Protection Kit.

- Includes:**
- Rancher Front Bumper (715003461)
  - Rancher Rear Bumper (715003462)
  - Body Side Protector (715003459)

**Fits: G2, G2L**  
**715003463**

• Requires Body Side Protector Extensions (715003460) for installation on MAX models.



**RANCHER FRONT BUMPER**

- The heavy-duty bumper designed to pull double duty: protect your ATV and anything it comes in contact with, while also enhancing the look of your ATV.
- Made tough and designed to deliver a rugged appearance, this bumper offers front protection for farmer, rancher and forestry applications.
- The low front end protection and plates allow you to use your ATV within cattle herds and guard the safety of both the vehicle and the animals.
- The flat front portion facilitates gently prodding cattle or pushing light objects, e.g. closing a fence.
- The full frontage coverage extends to provide an extra layer of defense to your headlights and radiator.
- Inside and outside anti-corrosion coating with durable powder coat finish.
- Not compatible with track systems, plows and front hitch.

**Fits: G2, G2L**  
**715003461**



**RANCHER REAR BUMPER**

- The heavy-duty bumper designed to pull double duty: protect your ATV and anything it comes in contact with, while also enhancing the look of your ATV.
- Made tough and designed to deliver a rugged appearance, this bumper offers rear protection for farmer, rancher and forestry applications.
- Ideal for using your ATV within cattle herds and guard the safety of both the vehicle and the animals.
- Coverage extends to provide an extra layer of defense to your tail lights.
- Inside and outside anti-corrosion coating with durable powder coat finish.
- Not compatible with track systems.

**Fits: G2, G2L**  
**715003462**



**BODY SIDE PROTECTOR**

- The heavy-duty fender guard designed to pull double duty: protect your ATV and also enhance the look of your ATV.
- Made tough and designed to deliver a rugged appearance, this fender guard offers full side protection for farmer, rancher and forestry applications.
- Built of durably bold 1.25" (3 cm) diameter steel-tube construction, with inside and outside anti-corrosion coating with durable powder coat finish.
- XT Front and Rear Bumpers or Rancher Front and Rear Bumpers are required for installation.

**Fits: G2 with XT or Rancher Bumpers, G2L with Rancher Bumpers**  
• Requires Body Side Protector Extensions (715003460) for installation on MAX models.

**Fits: G2L with XT Bumpers**  
**715003614**

**715003459**

**BODY SIDE PROTECTOR EXTENSIONS**

- (Not illustrated)
- This specially designed extension for Body Side Protector (715003459 or 715003614) is made specifically to fit and seamlessly integrate the look of Outlander MAX models.

**Fits: G2 MAX, G2L MAX**  
**715003460**

**OUTLANDER**



**XT FRONT BUMPER**

- Provides additional protection against the elements.
- Tough and durable, can be added on base Outlander model to convert vehicle into XT model.
- Large tube construction with textured black finish.
- Standard on XT model.

**Fits: G2**  
**715000947**



**XT FRONT BUMPER**

- Large tube construction.
- Protects vehicle frame against obstacles.
- Winch compatible.

**Fits: G2L**  
**715001910**



**EXTREME FRONT BUMPER**

- Ultra-sturdy build.
- Enhances front-vehicle protection.
- Compatible with XT Front Bumper.
- Fits the Apache 360 Track System (when side panels are removed).
- Not compatible with Front Hitch.

**Fits: G2**  
**715001286**



**EXTREME FRONT BUMPER**

- Ultra-sturdy build.
- Enhances front-vehicle protection.
- Compatible with XT Front Bumper.
- Fits the Apache 360 Track System (when side panels are removed).

**Fits: G2L**  
**715004279**



**XT REAR BUMPER**

- Provides additional protection against the elements.
- Tough and durable, can be added on base Outlander model to convert vehicle into XT model.
- Large tube construction with textured black finish.
- Standard on XT model.

**Fits: G2**  
**715000948**



**XT REAR BUMPER**

- Large tube construction.
- Protects vehicle frame against the obstacles.

**Fits: G2L**  
**715001911**



**RENEGADE**

**RENEGADE EXTREME FRONT BUMPER**

- Enhanced vehicle front protection.
- Required as a mounting point for Radiator Relocator (715001929).

**Fits: G2S**

**715002469**

ENHANCED  
VEHICLE FRONT  
PROTECTION.



**OUTLANDER**

**FENDER FLARE**

- Kit designed to deliver extra protection from dirt and debris, therefore a must if you enjoy riding in the mud.
- Made of injected plastic that hugs your vehicle fenders perfectly.
- Gives vehicle added flair for that rugged cool look.
- Includes front and rear extensions and all mounting hardware.

**Fits: G2 (except with 30" tires)**

**715001764**

**Fits: G2L**

**715001909**

**Fits: G2 (with 30" tires)**

- Standard on G2 X mr 1000R.

**715004250**



**FENDER FLARE EXTENSIONS**

- Block terrain debris from kicking up onto you as you ride or damaging your vehicle thanks to these extra-large Fender Flare Extensions, which also include mud flaps for added protection from mud/snow, especially when riding with track kits.
- Made of High Molecular Weight Polyethylene (HMWPE) for advanced abrasion resistance.
- Include front and rear extensions.

**Fits: G2**

- Must be used with Fender Flare for G2 (715001764).

**715003458**

**Fits: G2L**

- Must be used with Fender Flare for G2L (715001909).

**715003615**



**RENEGADE**



**FENDER FLARE**

- Integrated extended Fender Flare for sporty look and full body protection from dirt and water.
- Includes front and rear extensions and all mounting hardware.

**Fits: G2S (except X mr models)**

**715001681**

CATCH THE  
VIDEO

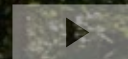

CAN-AMOFFROAD.COM

**IT'S A CARGO BOX.  
IT'S AN AUDIO RECEIVER  
& SPEAKER SYSTEM.  
IT'S LinQ VERSATILITY  
& CAN-AM INNOVATION.**

**OUTLANDER RENEGADE**

**LinQ**  
SYSTEM

**LinQ 11.5 GAL (43L) AUDIO CARGO BOX**

- Delivers the best sound quality on the market to sweeten your ride courtesy of a built-in full range high efficiency amplifier.
- Mounts on/off easily to hold/carry cargo safely and securely.
- The Bluetooth enabled receiver and 6.5" speakers are smartly concealed and integrated in the cover.
- Automatic shut-off function protects your battery by turning the system off after 10 minutes of inactivity.
- Backlit control panel perfect for night riding.
- Water-resistant speakers.
- LinQ Base (715002350) is required for G2L.
- LinQ Luggage Rack (715001734) is required for G2S.

**Fits: G2 (front only for Outlander 6x6 and Outlander MAX 2013-2014), G2L, G2S  
715003018**



MUST  
HAVE

**OUTLANDER RENEGADE**

**HEATED HAND GRIPS & THROTTLE COMBO**

Fits: G2, G2L (Wiring Cable (710004567) required for installation), G2S 715003250



**INDIVIDUAL THUMB & GRIP CONTROLS WITH 4 TEMPERATURE SETTINGS, ONE-TOUCH SHUTDOWN + EASY-TO-READ LED DISPLAY WITH DIMMER. ALL AT YOUR FINGERTIPS.**

- 1** LED dimmer facilitates reading temperature settings.
- 2** 4 temperature settings with individual controls for thumb and grips. Returns to previous heat setting.
- 3** One-touch shutdown.



**CYCLOPS 360° PANORAMIC HD VIDEO CAMERA**

- Features a 220-degree wide-angle lens.
- Video resolutions up to 4K at 30 frames per second.
- Professional 16MP quality photos.
- Rugged, light and portable.
- Magnetic mount for vibration-free footage and mounting to any metal surface.
- Comes with 32GB Class 10 micro SD card.
- Waterproof case up to 164' (50m).
- Wi-Fi available to remotely control your camera from your smartphone or computer with the free CG360 App.
- 16 modes and effects, including driving mode, loop recording, time lapse and slow motion.
- Comes with 10 mounting accessories.
- Compatible with VR goggles.



9700020090



**HEATED VISOR OUTLET**

- Strategically positioned on vehicle to maintain your agility.
- Optional visor outlet that delivers fog-free riding.
- Quick and easy installation.
- Sold individually.
- Heated Visor not included.

Fits: G2, G2L 715001246



**OUTLANDER**

**HEATED PASSENGER GRIPS & VISOR OUTLET**

- Replace your stock passenger handles.
- Dual temperature switch integrated into seat arm for 3-zone heated handles and grips.
- Heated visor outlet integrated into seat arm.

Fits: G2, G2L (MAX models only) 715001926

Fits: G2 (2013-2014) (MAX models only) 715002116



**WIRING CABLE**

- Required for installation of Heated Hand Grips & Throttle Combo.

Fits: G2L 710004567



**OUTLANDER RENEGADE**



**BAJA DESIGN ENGINEERS. THE SCIENTISTS OF LIGHTING.**



**NEW BAJA DESIGNS HIGH BEAM KIT**

- Thanks to their direct bolt-on and plug-and-play installation right into the original high beam location, upgrading from your stock high beam lights to these powerful Baja Designs Squadron Pro LED Lights becomes child's play.

Fits: G2 715004284

- Each spot is equipped with 4 Cree LEDs producing 4,900 lumens at 40 watts.
- Driving/Combo light pattern for smooth blend of light for both near field applications and distance.

**FRONT BUMPER LIGHTS**

- 2 x 900 lumens 10W LED Cree light kit.
- Long-range illumination up to 350' (107 m), drawing less than 1 amp per light.
- Include multi-position clamps that fit on various tubing sizes.
- Not EC compliant.

Fits: G2 (except X xc), G2L 715001741



**AUXILIARY WINDSHIELD LIGHTING**

- 2 premium LED spots for Deluxe Fairing for both increased output and directional lighting.
- 1,800 lumens.
- 2 10W LED Cree light kit.
- Long-range illumination up to 350' (107 m), drawing less than 1 amp per light.

Fits: Deluxe fairing 715003115



**RAM LED SPOTLIGHT**

- 540 lumens LED light (9 Watt) heavy-duty spotlight standard-equipped with 1" (2.5 cm) diameter rubber-coated double ball and socket system.

710005423 - Black



**CENTER CONSOLE DAY LIGHT**

- Mountable on top end of center console.
- Enhances look of vehicle.

Fits: G2S (except X mr) 715000691



**GARMIN+ MONTANA+ 680T GPS**

- Rugged and waterproof, the Montana 680T is element-proof.
- 4-inch dual-orientation, sunlight-readable touchscreen and glove-friendly touchscreen display, to give you vivid colors and high-resolution images.
- 8-megapixel autofocus camera automatically geotags photos.
- Tracks both GPS and GLONASS satellites for improved positioning and typically faster fixes.
- Preloaded TOPO maps, plus 1-year BirdsEye Satellite Imagery subscription.
- 3-axis compass with barometric altimeter.
- Specific GPS cradle included (vehicle mounting kit required).
- Includes a preloaded map for US.

Fits: G2, G2L, G2S 715002830

**EUROPEAN VERSION**

- EC compliant.
- Includes preloaded European recreation map.

715003456

**CANADIAN MAP FOR GARMIN MONTANA 680T GPS**

- Additional and readily-programmable Canadian basemap for Garmin Montana 680T GPS system.
- Requires Garmin Montana 680T GPS (715002830).

710005065

**GPS RAM+ MOUNT FOR HANDLEBAR**

- Convenient bracket for installing the Garmin Montana GPS (not included) onto your unit's handlebar.

Fits: G2, G2L, G2S 715001985



**YUSA+ AUTOMATIC 1 AMP BATTERY CHARGER**

- Keeps your battery charged and ready to ride.
- Hook it up - plug it in - charge. Includes adapter and clips.
- 3-stage charge cycle switches automatically to maintenance mode.
- Easy-to-read 3-color LED charge monitor.
- Built-in overcharge prevention.

529036307



**BE READY FOR ANYTHING WITH THE RUGGED HEAVY-DUTY PULLING POWER OF A WINCH!**

**OUTLANDER**

**CAN-AM TERRA BY SUPERWINCH<sup>+</sup>**

- Heavy-duty 4-way roller fairlead.
- Ergonomic clutch handle.
- Rugged all-steel gears and bushings, provides more torque and longer life.
- Automatic 100% load-holding brake.
- Sealed solenoid for all weather protection.
- Corded 10 ft. (3 m) weather sealed hand-held remote.
- Weather sealed handlebar mounted switch.
- EC Compliant.



**CAN-AM TERRA 25 WINCH BY SUPERWINCH**

- Pulling strength capability of 2,500 lb (1,134 kg).
- 50 ft. of 3/16" (15.2 m of 4.8 mm) wire steel cable.

Fits: G2, G2L  
715003475



**CAN-AM TERRA 35 WINCH BY SUPERWINCH**

- Pulling strength capability of 3,500 lb (1,588 kg).
- 50 ft. of 13/64" (15.2 m of 5.2 mm) wire steel cable.

Fits: G2, G2L  
715003476

**OUTLANDER RENEGADE**

**WARN<sup>+</sup> PROVANTAGE**

- Patented roller disc brake for outstanding control while winching.
- Ergonomic clutch handle.
- Three-stage planetary gear train for smooth, efficient operation.
- All-metal gear housing and gears.
- Fully sealed motor and drive train to keep the elements out.
- Corded remote and mini-rocker control switch with integrated socket.
- Limited lifetime warranty for mechanical components and 3-year warranty for electrical components.
- Winch mounting plate (71500927) is required for G2S.
- Winch wire harness (715002453) is required for G2L.
- EC Compliant.



**WARN PROVANTAGE 2500-S WINCH**

- Double powder coated hawse fairlead.
- Pulling strength capability of 2,500 lb (1,134 kg).
- 50 ft. of 3/16" (15.2 m of 4.8 mm) synthetic rope.

Fits: G2, G2L, G2S  
715003472



**WARN PROVANTAGE 3000 WINCH**

- Roller fairlead.
- Pulling strength capability of 3,000 lb (1,361 kg).
- 50 ft. of 3/16" (15.2 m of 4.8 mm) wire steel cable.

Fits: G2, G2L, G2S  
715003474



**WARN PROVANTAGE 3500-S WINCH**

- Double powder coated hawse fairlead.
- Pulling strength capability of 3,500 lb (1,588 kg).
- 50 ft. of 3/16" (15.2 m of 4.8 mm) synthetic rope.

Fits: G2, G2L, G2S  
715003473

1 CHOOSE YOUR VEHICLE	2 CHOOSE YOUR WINCH <i>See page 35 for more information.</i>	3 INSTALLATION REQUIRES	
		HARNESS	MOUNTING PLATE
G2	Can-Am Terra Winches by Superwinch or Warn Provantage Winches	NA	NA
G2L	Can-Am Terra Winches by Superwinch or Warn Provantage Winches	715002453 (For Warn winches only)	NA
G2S	Warn Provantage Winches	NA	71500927

*Some products shown may not be available or homologated in your country. Contact your BRP dealer for local details.*

**OUTLANDER RENEGADE**



**WARN HAWSE FAIRLEAD**

- Double powder coated construction.
- Required to use the Synthetic Winch Cable (715004254) on Warn winches.
- To be used with synthetic winch cables only.

**Fits: Warn winches**  
715004255



**WINCH MOUNTING PLATE**

- Adds functionality to your Renegade.
- Fits Can-Am winches by Warn.

**Fits: G2S**  
715000927

**WIRELESS REMOTE CONTROL**

- The system is quick and easy to install, thanks to a wiring harness with an integrated antenna and all necessary mounting hardware.
- The system allows you to operate your winch from anywhere within a 50' (15.2 m) radius, increasing your recovery options.
- All components are weatherproof.

**Fits: Warn winches**  
715002542



**WIRED REMOTE CONTROL**

- This kit allows winch owners to add the hand-held remote to their winch.
- Works in conjunction with the mini-rocker switch.
- EC compliant.

**Fits: For ATVs with handlebar winch remote socket.**  
710002270

**Fits: Superwinch winches**  
710004887

**Fits: ATVs without the winch remote socket on the handlebar**

- Side panel Remote socket (715003651) is required.
- EC compliant.

710001002



**WARN REMOTE SOCKET**

- (Not illustrated)
- Winch remote socket, located on side panel is required for wired remote control.

715003651

**WINCH WIRE HARNESS**

- (Not illustrated)
- Required plug-and-go wiring to install Warn winch only.
- Not required for Can-Am Terra winch.

**Fits: G2L**  
715002453

**HARDWARE ADAPTER KIT**

- (Not illustrated)
- Required to install Warn Winch Kit (715002500, 715002561, 715002499) on 2016 and up models.
- Required to install Can-Am Terra 25 Winch (715002167) and Can-Am Terra 35 Winch (715002057) on G2L 2017 and up models.

715003477

**WINCH ACCESSORIES KIT**

- Get the most out of your winch.
- Double your pulling power, change your pulling direction and keep your winch in proper working order.
- Includes tree straps, snatch block, shackle and winching gloves.

715002409



**ROLLER FAIRLEAD**

- Features top, bottom and side rollers for less cable wear and smoother operation from any direction for easier winching.

**715000011 • Warn**  
**705204571 • Superwinch**



**HOOK WITH SAFETY LATCH & STRAP KIT**

- Heavy-duty winch-rope hook with stainless steel snap.
- Includes a nylon safety strap.

715003523



**REPLACEMENT WIRE ROPE**

- Play it safe, always carry a replacement wire rope.
- 3,500 lb (1,588 kg) pulling strength.

**Fits: ATV SuperWinch**  
• 50 ft. of 7/32" (15.2 m of 5.5 mm) wire rope.

705009321

**Fits: ATV Warn winches**  
• 50 ft. (15.2 m) aircraft grade steel wire.  
• 3/16" (4.8 mm) diameter.

715000047



**SYNTHETIC WINCH CABLE**

- Easier to manipulate than steel cable.
- Replaces the original cable on any factory installed Warn winch or sold as an accessory by BRP.
- Kit includes synthetic rope and rock guard sleeve.
- Always use with new hawse fairlead (715004255).
- 50 ft. (15.2 m).
- 3,500 lb (1,588 kg) pulling strength.

715004254



**OUTLANDER**



**FRONT RECEIVER HITCH**

- Front receiver hitch for Outlander with or without a winch.
- This hitch offers 1,300 lb (590 kg) of towing capacity.
- Allows you to maneuver your trailer easily in tight, confined areas.
- Hitch bar sold separately.
- Not compatible with Extreme Front Bumper and Rancher Bumper.

**Fits: G2**  
715000921

**OUTLANDER RENEGADE**



**FRONT & REAR HITCH DRAWBAR**

- Standard on 2" (5 cm) receiver hitch.
- It offers 1,300 lb (590 kg) of towing capacity.
- Hitch ball not included.

**Fits: G2, G2L, G2S**  
715000972

**EUROPEAN VERSION**  
• Drawbar with 2" (50 mm) hitch ball.  
715001473  
705206264 (T Homologated)



**REAR RECEIVER HITCH**

- E-coat finish.
- Does not affect ground clearance.
- Trailer ball not included.
- This hitch offers 1,300 lb (590 kg) of towing capacity.

**Fits: G2L, G2S**  
715001329



**RUBBER RECEIVER PLUG**

- Rubber cap for 2" (5 cm) hitch receiver.

705204503

**REAR HITCH**

- E-coat finish.
- Fixed hitch ball mounting bracket.
- Provides fixed mounting point for trailer ball to provide vehicle with towing capabilities.
- This hitch offers 1,300 lb (590 kg) of towing capacity.
- Hitch ball not included.

**Fits: G2, G2L, G2S**  
715001925





**WE'LL MAKE YOU  
READY FOR MUD.**

**OUTLANDER**

**OUTLANDER RADIATOR RELOCATOR KIT**

- Relocates radiator to top mount position.
- Prevents cooling performance loss in muddy conditions.
- Uses existing radiator.
- Includes support, hardware and hoses.
- Engineered for easy cooling system bleeding and maintenance.
- Radiator not included.

**Fits: G2, G2L**  
**715001930 • Black**



**RELOCATE YOUR RADIATOR  
UP & AWAY FROM THE MUD!  
YOU'LL LEAVE OVERHEATING  
BEHIND AND RIDE COOL!**

**OUTLANDER SNORKEL KIT**

- Comprehensive kit.
- Extended air intakes and CVT exhaust.
- CVT Outlet integrates into pod cover.
- Ideal for muddy conditions.
- Must be installed on a vehicle without XT handlebar protector kit.
- For 6x6, appropriate gauge support is required for best fit and finish.
- Not compatible with windshields.

**Fits: G2, G2L**  
**715002392**  
**Fits: G2 (2012-2014 only)**  
**715001730**  
**Fits: G2 (X mr models only), G2L (X mr models only)**  
• Raised horn only.  
• Provides higher intake.  
• For best fit and finish, appropriate gauge support is required.  
**715002518**



**TRANSFORM YOUR VEHICLE INTO THE ULTIMATE  
CREEK CONQUERING MUD-RIDING MACHINE!**

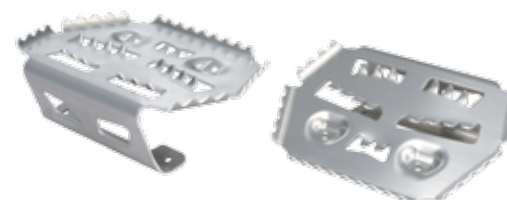

**X MR TRACTION PLATES**

- Provide extra foot grip for driver when riding in extreme mud conditions.
- Help driver to maintain ideal riding position to maximize vehicle traction.
- Made of aluminum.
- Not meant for a passenger.

**Fits: G2, G2L (MAX models only)**  
**715001752 • Aluminum**

**FOOTPEG KIT**

- Provides maximum integrated grip and more stability during vigorous riding.
- Kick-up end generates added grip during hard cornering.
- Made of aluminum.
- Sold in pairs.

**Fits: G2, G2L**  
**715001131**



**RENEGADE**



**RENEGADE SNORKEL KIT**

- Comprehensive kit.
- Extended air intakes and CVT exhaust.
- CVT Outlet integrates into pod cover.
- Ideal for muddy conditions.

**Fits: G2S**  
**715001928**

**ADAPTOR KIT**

- (Not illustrated)
- Necessary to install the G2S Snorkel Kit (715001928) on 2012 to 2014 models.

**Fits: G2S (for 2012-2014 models only)**  
**715003122**



**RENEGADE RADIATOR RELOCATOR KIT**

- Relocates radiator to top mount position.
- Prevents cooling performance loss in muddy conditions.
- Uses existing radiator.
- Includes support, hardware and hoses.
- Engineered for easy cooling system bleeding and maintenance.
- Radiator not included.
- Renegade Extreme Front Bumper (715002469) required for installation (except X mr).

**Fits: G2S**  
**715001929**

**OUTLANDER RENEGADE**

**MUD STRAP**

- Convenient sturdy grab-handle.
- Lets drivers redistribute their weight for improved traction in demanding conditions.
- Not compatible with XT Handlebar Protector Kit (703100352).

**Fits: G2, G2L, G2S**  
**715003053**



**RADIATOR PROTECTOR**

- Metal shield which mounts over radiator face, providing protection from stones and branches.

**Fits: G2, G2S (except G2S with 500 engine)**  
**715001744**

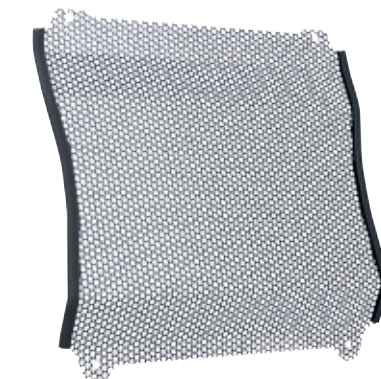



**YOSHIMURA GIVES YOU THE EDGE WITH MORE PERFORMANCE & LESS WEIGHT.**

**OUTLANDER**



**YOSHIMURA SLIP-ON EXHAUST**

- Made from 304-grade stainless steel.
  - Better sounding, better looking and lighter than stock muffler.
  - USDF/USDA approved spark arrester.
  - NON EPA compliant (for racing application only).
  - Not EC compliant.
  - Fuel injection system tuning not required.
- Fits: G2 (except 6x6 models)**  
715001738

**RENEGADE**



**YOSHIMURA SLIP-ON EXHAUST**

- Made from 304-grade stainless steel.
  - Better sounding, better looking and lighter than stock muffler.
  - USDF/USDA approved spark arrester.
  - NON EPA compliant (for racing application only).
  - Not EC compliant.
  - Fuel injection system tuning not required.
- Fits: G2S (except X mr models)**  
715001739

**OUTLANDER RENEGADE**

**FOX SHOCKS**

- Engineered for the more aggressive riders.
  - Offers increased bump absorption and better roll control.
  - Offers a slightly firmer ride than standard kits but remains very useable for all-around use.
  - Kit includes 4 shocks and springs.
  - Rebuildable.
  - Threaded preload adjusters.
- Fits: G2 (except X mr, XT-P, Limited & 6x6), G2 X mr 650 & G2S (base model with 500 & 570 only)**  
715001471



**FOX PERFORMANCE SHOCKS 1.5 PODIUM X RC2 HPG**

- High-performance front and rear shocks.
  - Allow handling to readily adapt to terrain and riding style.
  - Easy-adjust dual-speed compression, rebound and preload settings.
  - Standard on G2S X xc.
- Fits: G2 (except X mr, Limited & 6x6), G2 X mr 650 & G2S (base model & X mr 570 only)**  
715003201



**FRONT SHOCK COVERS**

- Feature ventilation holes.
  - Offer added protection in rough terrain and weather conditions.
  - Sold in pairs.
- Fits: G2, G2L, G2S**  
715500301

**HEAVY-DUTY SPRINGS**

- Heavy-duty springs provide enhanced stiffness.
  - Perfect for snow clearing and hauling heavy loads.
  - Improves handling and helps prevent accidental overturns.
  - Sold in pairs.
  - Standard on Outlander Pro and Mossy Oak models
- Fits: G2**  
**FRONT**  
G2 (base model, DPS, XT, X mr with 650 engine only & Limited), G2S (base model with 500 & 570 engines only)  
715003199  
**REAR**  
G2 (base model, DPS, XT & X mr with 650 engine only), G2S (base model with 500 & 570 engines only)  
715003200



Front

Rear

**FOAM AIR FILTER BY TWINAIR†**

- Maximizes performance by increasing air flow throughout RPM range.
  - Maintenance-friendly, i.e. just wash, re-oil and re-use after riding in severely dusty/muddy environments.
- Fits: G2, G2S**  
715001333



Some products shown may not be available or homologated in your country. Contact your BRP dealer for local details.



**TRAILERING COVERS**

- Heavy-duty canvas made of UV-resistant solution-dyed polyester.
- Inner soft liner protects windshield and colored panels from abrasion.
- All high abrasion areas are reinforced with a double canvas layer.
- Opening for fuel cap access.
- Weather-resistant trawling cover protects your vehicle during transportation.
- Quick and easy installation.
- Designed to perfectly fit your vehicle with or without Can-Am accessories.

**STORAGE COVERS**

- Weather-resistant storage cover.
- For vehicle storage only.
- UV-resistant solution-dyed polyester construction.
- Quick and easy installation.
- Designed to perfectly fit your vehicle with or without Can-Am accessories.

**Fits: G2 (except MAX models)**  
715001737  
**Fits: G2 (MAX models only)**  
715001736

**Fits: G2L (except MAX models)**  
715002026  
**Fits: G2L (MAX models only)**  
715002025

**Fits: G2S (except X mr models)**  
715000683

**Fits: G2 Xmr (except 1000R), G2L Xmr, G2S, G2S Xmr**  
715001720  
**Fits: G2 MAX, G2L MAX, G2 Xmr 1000**  
715001668

**Fits: G2L (except MAX models)**  
715001916

**Fits: G2L (except MAX models)**  
715001597 • Mossy Oak Break-Up Country Camo  
**Fits: G2L (MAX models only)**  
715001735 • Mossy Oak Break-Up Country Camo



**DECAL**  
• 6" x 12 3/4" (15 cm x 32 cm)  
704901483

**LICENSE PLATE BRACKET**

- Provides specific area to install license plate.
  - Mounts to rear of vehicle.
- Fits: G2L** 715002498  
**Fits: G2S** 715001401



**LOCKABLE GAS TANK CAP**

- Protects your fuel.
  - Meets EPA requirements.
- Fits: G2, G2L, G2S**  
860200387 • Black



**CUP HOLDER**  
• Mounts easily to handlebars or racks.  
715000121

**RATCHET TIE-DOWNS**

- 400 lb (181 kg) safe working load.
  - 1" x 10' (2.5 cm x 3 m) strap with Sea-Doo, Ski-Doo and Can-Am logos.
  - Deluxe ratchet with rubber handle.
  - Coated S hooks.
  - Pack of 2.
- 860200447 • Black/Grey



**FLAG**

- Make sure everyone knows what you're riding.
  - Perfect for the dunes and new riders.
  - 8-foot (2.4 m) length.
  - Includes flag mount (715000127).
- 715000277 • Yellow



**FLAG MOUNT**  
715000127

**WITH THE NEW APACHE BACKCOUNTRY TRACK SYSTEM.**

- GO OFF THE BEATEN PATH
- CLIMB HIGHER
- RIDE IN DEEP SNOW



**THE PERFECT FUSION OF SKI-DOO SNOWMOBILE & APACHE TRACK TECHNOLOGY. DELIVERS BETTER DEEP-SNOW PERFORMANCE THAN ANY OTHER ATV TRACK SYSTEM.**



Some products shown may not be available or homologated in your country. Contact your BRP dealer for local details.

**OUTLANDER RENEGADE**

# APACHE TRACK SYSTEMS

• Highly engineered track system provides ultimate traction in deep snow for your Can-Am vehicle.

• Heavy-duty components ensure reliability and the design offers excellent acceleration, turning, braking and side-hilling performance.

• The DPS<sup>+</sup> module, included in the mounting kits, optimizes your Dynamic Power Steering (DPS) performance by maximizing steering agility at lower speeds while providing firmer steering at cruising speeds. It also provides a speed correction factor for the speedometer.

## WINTER TRACKS

Can-Am's new Apache Backcountry Track System is the perfect fusion of BRP's renowned snowmobile and innovative Apache 360 Track System technologies. It delivers the highest ground clearance, the most flotation, and the best deep-snow performance of any ATV track kit on the market today. Period. An efficient frame and rail design ensures weight is spread evenly on snow so you always enjoy higher traction, remarkable acceleration, turning, braking and side-hilling. And it's the only kit available with a 13.5" X 96" (34 cm x 244 cm) front track / 14" X 138" (36 cm x 351 cm) rear track, which adds up to the largest contact patch anywhere.

**CLIMB HIGHER, RIDE IN DEEPER SNOW AND GO OFF THE BEATEN PATH.**



## YEAR ROUND TRACKS

The Apache 360 and 360 LT Track Systems offer a unique adjustable contact patch engineered to take on the toughest conditions, year round. Their built-in versatility means you can optimize your attack angle in rough terrain, or dial it down for enhanced deep-snow flotation – it's that easy. They're great in muddier, softer spring thaw conditions so you can work or play wherever and whenever you want. Their superior ground adhesion makes them a favorite for navigating swamps and bogs.



### APACHE 360 LT TRACK SYSTEM

- Multifunctional tracks designed to support heavy loads and to fit on most Can-Am off-road vehicles.
- Extra contact patch adjustment for better performance over rough terrain.
- Contact patch is 7 to 9% bigger than the Apache 360's.
- Average ground clearance of 17.3" (44 cm).
- 1" (2.5 cm) lugs in the front and 1.25" (3.2 cm) in the back.
- Apache 360 Mounting Kit and Apache 360 LT ATV Adaptor are required.
- EC Compliant.

**Fits: G2 (except 6x6), G2S**  
715003064

### APACHE 360 TRACK SYSTEM

- Multifunctional tracks perfect for any Can-Am ATV.
- 1" (2.5 cm) lugs in the front and 1.25" (3.2 cm) in the back.
- Average ground clearance of 16" (41 cm).
- Apache 360 Mounting Kit is required.
- EC Compliant.

**Fits: G2 (except 6x6 models), G2L, G2S**  
715001981



Unique adjustable contact patch system to tackle the toughest year-round conditions.



Easy installation and quick conversion from tires to tracks.



Rubber over molded heavy-duty double bearing wheels and offset wheel spacing reduce friction and vibration while ensuring reliability.

### NEW APACHE BACKCOUNTRY TRACK SYSTEM

- Designed to deliver the best flotation level and deep-snow performance on the market.
- Contact patch is 23% bigger than the Apache 360 LT.
- Impressive ground clearance of 20.3" (51.6 cm), keeps the vehicle out of deep snow.
- Aggressive track design with 2" (5 cm) lug height for maximum traction on snow.
- Apache Backcountry Mounting Kit is required.
- For winter use only.
- EC Compliant.

**Fits: G2 (except 6x6), G2S**  
715003042

### NEW APACHE BACKCOUNTRY MOUNTING KIT

- (Not illustrated)
- Simple system that reduces installation time.
- Includes DPS Module.
- Required for installation of the Apache Backcountry Track System.

**Fits: G2 (except 6x6), G2S**  
715003043



### IDLER WHEEL KIT

- Reduces drag and rolling resistance.
- Includes 2 wheels, brackets and hardware.
- Add up to 2 kits per rear track.
- Can extend slider life in hardened snow conditions.

**Fits: Apache Backcountry Track System, rear tracks only**  
860201230 • 141 mm



### SLIDERS WITH VESPEL<sup>+</sup> INSERTS

- Use DuPont Vespel inserts for less friction.
- Longer life.
- Can be cut to desired length.
- 8 needed per vehicle.
- Sold individually.

**Fits: Apache Backcountry Track System**  
503194815 • Black

### APACHE 360 MOUNTING KIT

- (Not illustrated)
- Simple system that reduces installation time.
- Includes DPS Module.
- Requires Apache 360 LT ATV Adaptor (715003063) for installation of the Apache 360 LT Track System.

**Fits: G2 (except 6x6 models), G2L, G2S**  
715002388

### APACHE 360 LT ATV ADAPTOR

- (Not illustrated)
- Required to install an Apache 360 LT Track System (715003064).
- Apache 360 Mounting Kit (715002388) also required.

**Fits: G2 (except 6x6 models), G2S**  
715003063

### DPS MODULE

- (Not illustrated)
- Calibrates speedometer and DPS support for Apache and Backcountry Track Kits.

**Fits: G2L (except base models), G2 (except base models), G2S**  
715001202

### AIR INTAKE PRE-FILTER

- Adds extra protection for your engine in harsh riding conditions.
- Filter blocks particles larger than 0.005".
- A pre-filter is necessary to maintain the vehicle warranty when an Apache 360 Track System or an Apache 360 LT Track System is installed.

**Fits: G2, G2L, G2S**  
715000291





**PLOW KITS**

**OUTLANDER**

**TURN YOUR VEHICLE INTO A SNOW CONQUEROR!**

**60" (152 CM) ALPINE FLEX PLOW KIT**

Fits: G2, G2L  
715003149

- KIT INCLUDES:**  
 60" (152 cm) Alpine Flex Plow  
 715001181 - Black  
 Alpine Flex Push Frame with Quick-Attach System  
 715001847  
 Plow Mounting Kit  
 715001411



**60" (152 CM) ALPINE SUPER-DUTY STRAIGHT PLOW KIT**

Fits: G2, G2L  
715003148

- KIT INCLUDES:**  
 60" (152 cm) Alpine Super-Duty Straight Plow  
 715000648 - Yellow  
 Alpine Super-Duty Push Frame with Quick-Attach System  
 715001182  
 Plow Mounting Kit  
 715001411



**OUTLANDER RENEGADE**

**54" (137 CM) ALPINE SUPER-DUTY STRAIGHT PLOW KIT**

Fits: G2, G2L, G2S  
715003147

- KIT INCLUDES:**  
 54" (137 cm) Alpine Super-Duty Straight Plow  
 715000208 - Black  
 Alpine Super-Duty Push Frame  
 715001064  
 Plow Mounting Kit  
 715002858



**ULTRA-FLEXIBLE UHMWPE CONSTRUCTION DELIVERS THE HIGHEST IMPACT-STRENGTH RATING OF ANY THERMOPLASTIC PLOW ON THE MARKET!**

**OUTLANDER RENEGADE**

**PLOWS**

**ALPINE FLEX PLOW 54" (137 CM) & 60" (152 CM)**

- Clears 50" (127 cm) or 54" (137 cm) when plow is angled.
- Ideal for clearing narrow areas, like sidewalks.
- Plow made of flexible UHMWPE, which delivers the highest impact strength of any thermoplastic presently made.
- Enormous flex action prevents damaging your plow when accidental impact happens.
- Impact absorption properties return plow to its original shape.
- Rearward release action practically eliminates jolts from being transferred to the driver or unit.
- Attaches and detaches effortlessly thanks to a fast and easy mounting system.
- Blade-turning mechanism mounted high to eliminate having to bend down to change or adjust blade's angle.
- High pivot point keeps plow on pavement.
- Compatible with all Alpine Flex Plow accessories to further enhance plow versatility.

Fits: G2, G2L, G2S

54" (137 cm)  
715001677

60" (152 cm)  
715001181



60" (152 cm)

**BUILD YOUR CUSTOM ALPINE FLEX PLOW SYSTEM IN 4 EASY STEPS**

1 FIND YOUR PLATFORM	2 MATCH THE PUSH FRAME	3 MATCH THE MOUNTING KIT	4 CHOOSE THE PLOW WIDTH	+ ADD
G2, G2L	715001847	715001411	60" (152 cm) Alpine Flex Plow 715001181 OR 54" (137 cm) Alpine Flex Plow 715001677	Add Alpine Flex Push Frame Extension (715001389) if using Alpine Flex UHMW Thermoplastic Plow with Apache 360, 360 LT and Backcountry Track System
G2S	715001848			

Some products shown may not be available or homologated in your country. Contact your BRP dealer for local details.

**PUSH FRAME**

**ALPINE FLEX PUSH FRAME WITH QUICK-ATTACH SYSTEM**

- Includes cable saver limit switch and plow roller fairlead.
- Refer to the chart on page 50 for the fitting.

715001848  
715001847



**ALPINE FLEX PUSH FRAME EXTENSION**

- Bolt-on push frame extension for use with Apache 360, 360 LT and Backcountry Track System.
- Does not alter plow functionality.
- Fits Alpine Flex Push Frames (715001847 and 715001848).

**Fits: Alpine Flex Plows**  
715001389



**MOUNTING KIT**

**PLOW MOUNTING KIT**

- (Not illustrated)
- Required to install Alpine Super-Duty Push Frames with Quick-Attach System (715001182, 715001474) and Alpine Flex Push Frames (715001847, 715001848).
- Mounting plate precision-designed to stay on year round without compromising ground clearance.

715001411

- Fits with or without Can-Am Skid Plates.
- Refer to the chart on page 50 for the fitting.

**ALPINE FLEX PLOW ACCESSORIES**

**ALPINE FLEX PLOW EDGE MARKERS**

- For a more accurate view of the width of your plow so you avoid damaging your curb, your car or your house.

**Fits: Fit Alpine Flex Plows**  
715001388

**ALPINE FLEX 8" (20 CM) PLOW EXTENSIONS**

- These conveniently extend your Alpine Flex Plow.

**Fits: Fit Alpine Flex Plows**  
715001385

**ALPINE FLEX DRIFT CUTTER**

- Keeps snow securely in the plow.
- Fits on either left or right side.
- Sold individually.
- Requires 8" (20 cm) Alpine Flex Extensions.

**Fits: Alpine Flex Plows**  
715001386



**ALPINE FLEX WEAR BLADE (STEEL)**

- Long lasting wear blade that provides a sharper cut than the stock wear blade.
- Replaces stock wear blade.

**Fits: Alpine Flex Plow**  
54" (137 cm)  
715001704

**Fits: Alpine Flex Plow**  
60" (152 cm)  
715001476

**ALPINE FLEX WEAR BLADE (PLASTIC)**

- Flexible UHMWPE plastic construction won't scratch your driveway.
- Replaces stock wear blade.

**Fits: Alpine Flex Plow 54" (137 cm)**  
715001703

**Fits Alpine Flex Plow 60" (152 cm)**  
715001475

- Stock replacement blade that is versatile for general plowing.

**Fits: Alpine Flex Plow**  
54" (137 cm)  
705203199

**Fits Alpine Flex Plow**  
60" (152 cm)  
705202835

**ALPINE FLEX PLOW RUBBER FLAP**

- (Not illustrated)
- Keeps snow away from the driver.
- Minimizes snow flowing over plow.
- Increases snow rolling effect.

**Fits: Alpine Flex Plow 60" (152 cm)**  
715001387

**Fits: Alpine Flex Plow 54" (137 cm)**  
715001767

**ALPINE SUPER-DUTY STEEL PLOWS** 49



**BLADE DESIGN OPTIMIZED FOR HIGHEST SNOW/DIRT ROLL-OFF AT ALL ANGLES.**

**OUTLANDER RENEGADE**

**PLOWS**

**ALPINE SUPER-DUTY STRAIGHT PLOW**

- Super-duty plow blades made from 12-gauge steel.
- Replaceable wear blades.
- Blades swivel left or right, 5 positions.
- Large pin designed for easy blade rotation to eliminate dirt and snow buildup at pivot point.
- Blade design provides best snow/dirt roll-off at any angle.
- Yellow-colored version Can-Am branded.

**Fits: G2, G2L, G2S**

**54" (137 cm)**  
• When angled, clears 48" (123 cm) path.

715000208 • Black  
715000647 • Yellow

**60" (152 cm)**  
• When angled, clears 53½" (136 cm) path.

715000209 • Black  
715000648 • Yellow



54" (137 cm)

**ALPINE SUPER-DUTY ONE WAY STATE PLOW**

- One-way "winged" state plow designed to throw snow higher.
- Wing end of plow measures 25" (63 cm) high and tapers down to 16" (41 cm).
- Rubber flap designed to keep snow away from driver.
- Yellow-colored version Can-Am branded.

**Fits: G2, G2L, G2S**

**60" (152 cm)**  
715000649 • Yellow  
715000207 • Black

**66" (168 cm)**  
715000650 • Yellow



60" (152 cm)

66" (168 cm)

# BUILD YOUR CUSTOM ALPINE SUPER-DUTY STEEL PLOW IN 4 EASY STEPS

1 FIND YOUR PLATFORM	2 MATCH THE PUSH FRAME	3 MATCH THE MOUNTING KIT	4 CHOOSE THE PLOW WIDTH	+ ADD 
G2, G2L	715001064 + 715002858 OR 715001182 + 715001411		66" (168 cm) Alpine Super-Duty One Way State Plow 715000650 - Yellow OR 60" (152 cm) Alpine Super-Duty One Way State Plow 715000649 - Yellow 715000207 - Black OR 60" (152 cm) Alpine Super-Duty Straight Plow 715000648 - Yellow 715000209 - Black OR 54" (137 cm) Alpine Super-Duty Straight Plow 715000647 - Yellow 715000208 - Black	Add Alpine Super-Duty Push Frame Extension (703500603) if using Alpine Super-Duty Steel Plow with Apache 360 and Backcountry Track System.
G2S	715001064 + 715002858 OR 715001474 + 715001411			

## PUSH FRAME

### ALPINE SUPER-DUTY PUSH FRAME WITH QUICK-ATTACH SYSTEM

- Tubes withstand roughest use.
- Mid-mount carriage provides up to 11½" (29 cm) lift.
- Fits all steel blade styles.
- Improved auto aligning quick-attach system, easy foot lever release pedal, cable saver limit switch preventing cable breakage by automatically stopping the winch.
- Fits on Plow Mounting Kit (715001411 & 715002858) depending on your vehicle platform.
- Refer to the chart above for the fitting.

715001182 • Includes plow roller fairlead  
715001474



### ALPINE SUPER-DUTY PUSH FRAME

- Super-duty push tubes withstand the roughest use.
- Mid-mount carriage provides up to 11½" (29 cm) of lift.
- Fits all steel blade styles.
- Quick-attach not included.
- Refer to the chart above for the fitting.

715001064



## MOUNTING KIT

### PLOW MOUNTING KIT

- (Not illustrated)
- Required to install Alpine Super-Duty Push Frames with Quick-Attach System (715001182, 715001474) and Alpine Flex Push Frames (715001847 and 715001848).
  - Mounting plate precision-designed to stay on year round without compromising ground clearance.
  - Fits with or without Can-Am Skid Plates.
  - Refer to the chart above for the fitting.

715001411

### PLOW MOUNTING KIT

- (Not illustrated)
- Required to install Alpine Super-Duty Push Frame (715001064).
  - Quick-release pins attach and detach plow blade and base assembly in minutes.
  - Simplified installation.
  - Can be used with or without Alpine Super-Duty Quick-Attach System (715000731).
  - No frame drilling required.
  - Refer to the chart above for the fitting.

715002858

## ALPINE SUPER-DUTY ACCESSORIES

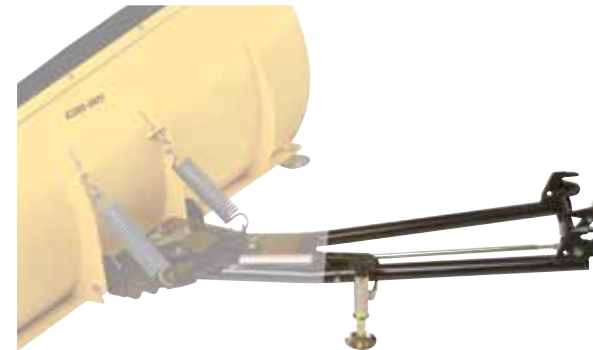

### ALPINE SUPER-DUTY QUICK-ATTACH SYSTEM

- Available as an option to upgrade Alpine Super-Duty Push Frame (715001064).
- The plow will be easy to install with this quick-attach system.
- Durable with a powder-coated rust-resistant finish.

Fits: Alpine Super-Duty Plow  
715000731

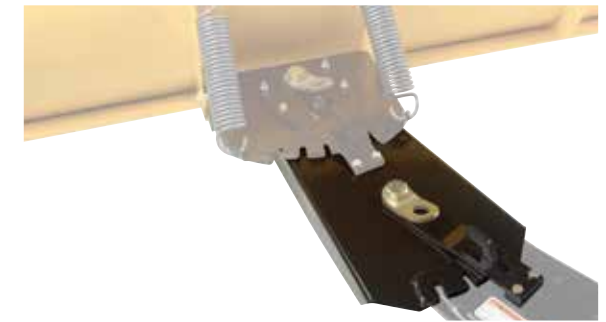

### ALPINE SUPER-DUTY PUSH FRAME EXTENSION

- 12 1/4" (31 cm) chassis extension for use with Apache 360 Track System.
- Increases angle and enables extra blade rotation.
- Fits on Alpine Super-Duty Push Frame (715001063, 715001064, 715001182 and 715001474).

703500603

### ALPINE SUPER-DUTY DRIFT CUTTER

- Helps keep snow in the plow.
- Designed with a rear pivot point.
- Works with both Straight and One Way State Blades.

Fits: Alpine Super-Duty Plow

Left  
715000217

Right  
715000218



### ALPINE SUPER-DUTY PULLEY KIT

- Pulley kit to be used in conjunction with the winch when using a snow plow.
- Recommended to increase winch efficiency.
- To be used with the XT Front Bumper.

Fits: Alpine Super-Duty Plow  
715000279



## OTHER PLOW ACCESSORIES

### ALPINE SYNTHETIC WINCH CABLE

- Specially designed for plowing applications.
- 8' (2.4 m) section of durable, extra-strong synthetic rope.
- Stands up to repeated, sharp angle pulls used to lift heavy plow blades.
- Temporarily replace your winch rope for plow season to save wear and tear on wire rope.

715000540



### PLOW ROLLER FAIRLEAD

- Larger diameter lower roller reduces wear on wire rope for plow application.
- For use with Alpine Super-Duty Plow.

Fits: G2  
705005715



### REAR TIRE CHAINS

- Improve your traction in mud and snow.
- Sold in pairs.

26" x 10" x 12"

715500218

25" x 10" x 12"

715000225

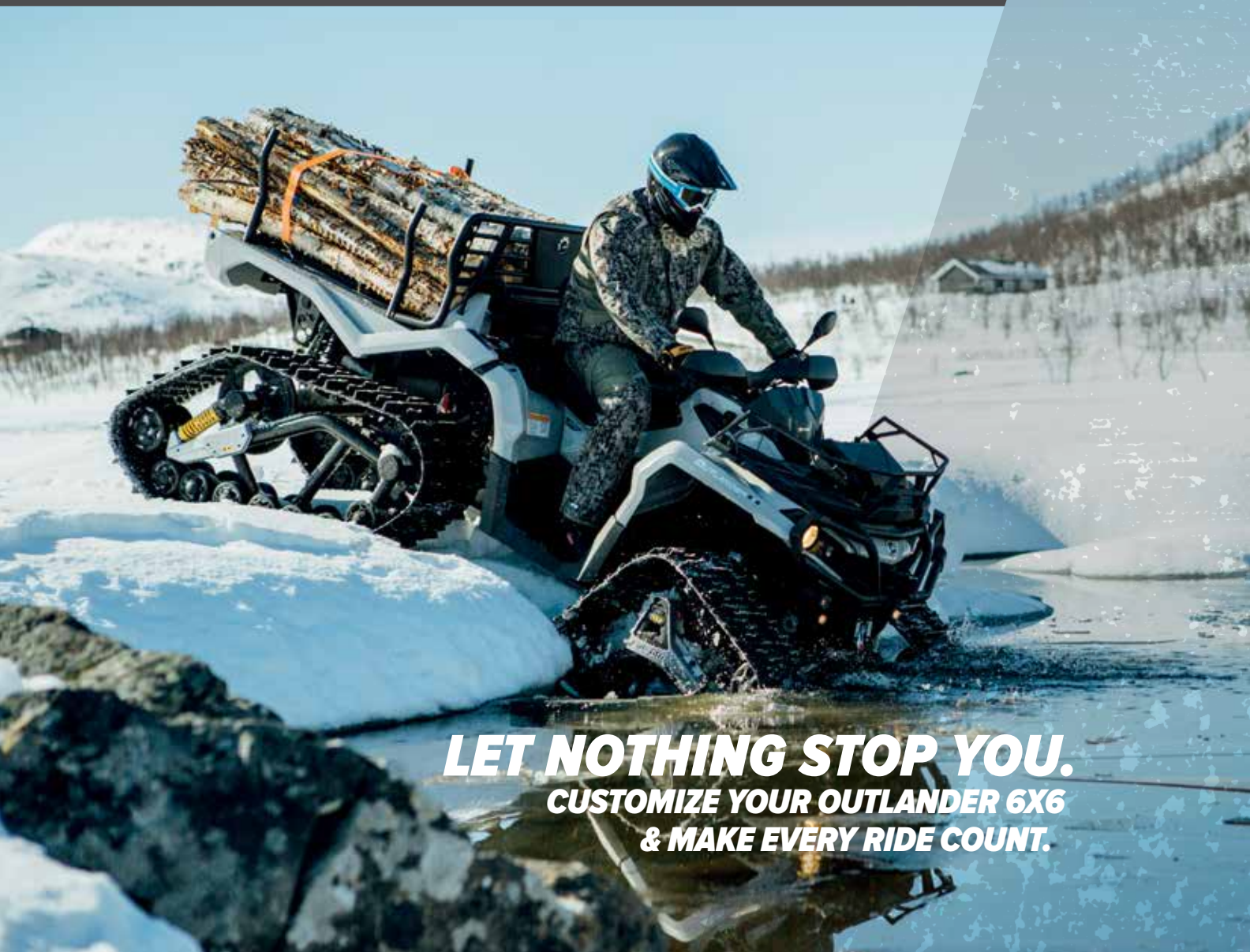

**LET NOTHING STOP YOU.  
CUSTOMIZE YOUR OUTLANDER 6X6  
& MAKE EVERY RIDE COUNT.**

**OUTLANDER 6X6**



**SIDE WALLS AND TAIL GATE**

- Allows for a quick and easy conversion of the cargo bed into a trunk with plenty of room.
- Rotationally molded walls provide extreme durability for hard work - in all conditions.

715002868 - Latin America/Asia Pacific  
715001989 - Europe

**HARD TOP**

- The hard top provides a 116 Gal (440L) cargo box.
- Locking secures your belongings.
- The cover raises assisted by gas cylinders.

**Fits: G2 (6x6 models only)**  
715002490 - Latin America/Asia Pacific  
715002394 - Europe



**NEW DRIVER BACKREST**

- Provides the rider's back with that extra support that makes riding that extra mile way more comfortable.
- Adjusts horizontally to match the driver's height and preference.
- Mounts and locks in firmly onto the vehicle.

**Fits: G2 (6x6 only)**  
715003611 - Latin America/Asia Pacific/Europe



**TAILGATE LIMITER KIT**

- 2 L-shape brackets that hold the tailgate open horizontally.
- Keeps tailgate flush with the rest of the flatbed for longer oversized cargo.

**Fits: G2 (6x6 models only)**  
715002534 - Latin America/Asia Pacific  
715002080 - Europe



**OUTLANDER 6X6**

**APACHE 360 LT TRACK SYSTEM**

- Exclusively for the Outlander 6x6.
- Cross obstacles up to 12" (30 cm) high.
- Enjoy superior acceleration, turning, braking, and side-hilling.
- Switch easily between enhanced attack angle or improved flotation.
- Reliable heavy-duty build.
- Can-Am designed technology.
- Mounting kit included.
- For winter use only.
- EC Compliant.

**Fits: G2 (6x6 2016 and up models only)**  
715002386  
**Fits: G2 (6x6 2014-2015 models only)**  
619590299



**LinQ SYSTEM**

**TAILGATE EXTENSION/DIVIDER**

- The sturdy tailgate extension provides a 10" (25 cm) extension to the cargo space.
- Thanks to the longer cargo bed, even large loads pose no problem.
- With the help of LinQ quick locks, the extension also acts as a solid space divider for the cargo bed.

**Fits: G2 (6x6 models only)**  
715002488 - Latin America/Asia Pacific  
715002017 - Europe



**LOG BARS**

- Log bars allow you to convert the cargo bed into a perfect transport space for 4' (120 cm) timber.
- The driver's safety is guaranteed by the protective front screen.

**Fits: G2 (6x6 models only)**  
715002486 - Latin America/Asia Pacific  
715001987 - Europe

**OUTLANDER 6X6**



**18 GAL (70L) UTILITY BOX**

- Wherever you go and whatever you do, this handy 18 Gal (70L) utility box is your mobile storage.
- The lid keeps your equipment safe from the elements in all conditions.
- Slides under the flatbed with handles for easy access.

**Fits: G2 (6x6 models only)**

715002487 • Latin America/Asia Pacific  
715001999 • Europe



**FLATBED PROTECTION TUBES**

- Bolt-on bumpers for the sides of the 6x6 flatbed.
- Protects the exterior plastic components of the flatbed from rocks, trees and other obstacles when traversing enclosed areas or loading cargo onto the bed.

**Fits: G2 (6x6 models only)**

715002489 • Latin America/Asia Pacific  
715002030 • Europe



**REAR WINCH KIT**

- The remote-controlled rear winch is a godsend when you want to pull yourself out of a tough spot or move heavy loads.
- Includes a fully-sealed Warn winch and all wiring and hardware needed for an easy and quick installation.
- Pulling strength capability of 3,000 lb (1,361 kg).
- 50 ft. of 3/16" (15.2 mm of 4.8 mm) wire steel cable.

**Fits: G2 (6x6 models only)**

715002484 • Latin America/Asia Pacific  
715002067 • Europe



**TARPAULIN**

- Fitted to cover all of the items in your cargo box thoroughly.
- Prevents splash from entering cargo box.
- Easily removable for quick access.

**Fits: G2 (6x6 models only)**

715002491 • Latin America/Asia Pacific  
715002416 • Europe

**STORAGE COVER**

- (Not illustrated)
- For storage use only.
- Heavy-duty elastic cord around bottom for secure fit.
- 100-dernier polyester construction.
- Fits with or without windshield and mirrors.

**Fits: G2 (6x6 models only)**

715002492 • Latin America/Asia Pacific  
715002415 • Europe



**ENGINEERED TO PROTECT & PRESERVE VEHICLE FRAME, ENGINE & DRIVETRAIN.**

**FULL BODY SKID PLATE**

- A full body plastic skid plate (10 mm HDPE) designed to protect the frame and the engine case from rough terrain conditions.
- The plastic allows your ATV to slide easily over stumps and logs.

**Fits: G2 (6x6 models only)**

715002485 • Latin America/Asia Pacific  
860200896 • Europe

**ITP TERRACROSS TIRE**

- This smooth-riding tire will command every bit of traction from the ground while still managing to float across loose snow, sand and mud.
- Features extreme-duty construction for improved puncture protection, extra-tough rubber compound for increased tread life, and the interlocking tread pattern and wide footprint make it one of the toughest and grippiest radials around.
- Not EC compliant.

**Fits: G2 XTP, G2 Limited**

**Front**  
26" x 8" x 14"  
705401906

**Rear**  
26" x 10" x 14"  
705502421



**GROUND-GRIPPING TRACTION MEETS LOOSE SNOW, SAND, & MUD MANEUVERABILITY. THE TOUGH TIRE WITH THE SMOOTH RIDE.**

**ZILLA TIRE BY MAXXIS\***

- Sold individually.

**Front**  
27" x 10" x 14"  
705401302  
**Rear**  
27" x 12" x 14"  
705501703



**CARLISLE ACT TIRE**

**Fits: G2 (500-1000 XT models only)**

**Front**  
26" x 8" x 12"  
705401333  
705401334 • CE

**Rear**  
26" x 10" x 12"  
705501769  
705501770 • CE

**Fits: G2 (400 XT models only)**

**Front**  
25" x 8" x 12"  
705400606  
705400326 • CE

**Rear**  
25" x 11" x 12"  
705500933  
705500598 • CE

**CARLISLE ACT HD TIRE**

**Front**  
26" x 8" x 12"  
705401736  
**Rear**  
26" x 10" x 12"  
705502297



**MAXXIS MUZZILLA TIRE**

- Not EC compliant.
- Fits: G2 (X mr 570 & 650 models only)**

**Front**  
28" x 8" x 12"  
705402131  
**Rear**  
28" x 10" x 12"  
705502645



**GORILLA SILVERBACK TIRE**

- AT30X9-14 Gorilla Silverback mud tire.
- Sold individually.
- Not EC compliant.

**Fits: G2 (850 & 1000 models only)**  
30" x 9" x 14"  
705402178



**CARLISLE BADLANDS A/R TIRE**

**Fits: G2 (500-1000 Base models only)**

**Front**  
26" x 8" x 12"  
705401331  
705401332 • CE  
**Rear**  
26" x 10" x 12"  
705501767  
705501768 • CE

*Some products shown may not be available or homologated in your country. Contact your BRP dealer for local details.*

*\*Consult your operator's guide/owner's manual for proper tire type and rim sizing. Improper tire type and rim selection may affect vehicle handling. Check with your local authorities for proper regulation.*



**CARLISLE TRAIL WOLF TIRE**

**Fits: G2 (400 Base models only)**  
 Front 25" x 8" x 12"      Rear 25" x 11" x 12"  
 705401625      705502164  
 705400607 - CE      705502165 - CE



**ITP HOLESHOT ATR TIRE**

**Fits: G2S**  
 Front 205/80R12      Rear 270/60R12  
 25" x 8" x 12"      25" x 10" x 12"  
 705400600      705500926  
 705400475 - CE      705500820 - CE



**DURO THRASHER TIRE**

**Fits: DS 90/70**  
 Front - 19" x 7" x 8"      Rear - 18" x 9.5" x 8"  
 V42711DGF000LL      V42712DGF010LL

**OUTLANDER X MR AND DEFENDER RIM**

- Cast aluminum rim with trend setting explosive styling so you can ride - and look - like a trailblazer.  
 - Front: 14" x 6.5" offset = 10 mm.  
**Fits: ATV (X mr models front & rear wheels)**  
 ■ 705401848 - Black and machined  
 ■ 705401849 - Black



**OUTLANDER X MR RIM - ITP-SS212\***

- Black with machining and clear coat rim.  
 - Matching Cap (705400963), Matching Nuts (250100100).  
 - Sold individually.  
**Fits: G2 (X mr models only)**  
 Front & Rear - 14" x 6"  
 705400877 - Black and machined



**NOTE:** Matching Nuts - 250100100 Black, 250100082 Chrome / Matching Cap - 705401541



**KENDA KLAW MXR TIRE**

**Fits: DS 90 X**  
 Front - 20" x 6" x 10"      Rear - 18" x 10.5" x 8"  
 V42711DGF01HLL      V42712DGF01HLL



**REAR TIRE CHAINS**

- Improve your traction in mud and snow.  
 - Sold in pairs.  
 26" x 10" x 12"      25" x 10" x 12"  
 715500218      715000225



**KENDA KNARLY TIRE**

**Fits: DS 250**  
 Front - 22" x 7" x 10"      Rear - 20" x 11" x 9"  
 S44710RCA000      S42710RCA000

**OUTLANDER RIM (CAMO MODEL)**

- Black with clear coat aluminum rim.  
**Fits: G2, G2L, G2S**  
 Front - 12" x 6" offset = 41 mm  
 705401127 - Black with clear coat  
 Rear - 12" x 7.5" offset = 51 mm  
 705501493 - Black with clear coat



**LOCKOUT 393 14" RIM BY VISION\***

- Sold individually.  
 - Matching Cap (705401362), Matching Nuts (250100100).  
 Front - 14" x 7"      Rear - 14" x 8"  
 Bolt circle pattern: 4/136 mm      Bolt circle pattern: 4/136 mm  
 Wheel offset: 4 + 3      Wheel offset: 4 + 4  
 705401363      705501787



**12" BEADLOCK RIM**

- Black with clear coat aluminum rim.  
 - Needs 16 bolts (250000435) for installing the Beadlock.  
 - Choice of Beadlock color (not included).  
**Fits: G2, G2L, G2S**  
 Front - 12" x 6"      Rear - 12" x 7.5"  
 offset = 41 mm      offset = 51 mm  
 705401678 - Black      705502244 - Black



**12" BEADLOCK**

- Cast aluminum beadlock.  
 - Must be installed on Front Rim (705401678) and Rear Rim (705502244).  
**Fits: G2, G2L, G2S**  
 ■ 705401763 - Can-Am Red  
 ■ 705401156 - Yellow  
 ■ 705401533 - Orange Crush  
 ■ 705401812 - Manta Green

**NOTE:** Matching Nuts - 250100100 / Matching Cap 705400928

**14" BEADLOCK RIM**

- Black with clear coat aluminum rim.  
 - Choice of beadlock color (not included).  
 - Needs 16 bolts (250000435) for installing the beadlock.  
**Fits: G2**  
 Front - 14" x 6.5"      Rear - 14" x 8"  
 offset = 41 mm      offset = 51 mm  
 705401594      705502146



**14" BEADLOCK**

- Cast aluminum beadlock.  
 - Must be installed on Front Rim (705401594) and Rear Rim (705502146).  
**Fits: G2**  
 ■ 705401586 - Manta Green  
 ■ 705401702 - Octane Blue  
 ■ 705401837 - Can-Am Red  
 ■ 705401840 - Black

**NOTE:** Matching Nuts - 250100100 / Matching Cap 705400928

**RIMS**

**14" RIM**

- Premium cast aluminum black painted with machining and clear coat rim.  
 - Center hole: 72 mm  
 - Bolt circle pattern: 4/136 mm

**Fits: G2 DPS, G2 XT, G2 MAX 650, G2 MAX XT, G2 MAX Limited**  
 Front - 14" x 6.5"      Rear - 14" x 8.5"  
 offset = 40 mm      offset = 50 mm  
 705401853 - Black and machined      705502402 - Black and machined  
 705401852 - Black with clear coat      705502401 - Black with clear coat  
 705401851 - Silver with clear coat      705502400 - Silver with clear coat



**NOTE:** Matching Nuts - 250100100 Black, 250100082 Chrome / Matching Cap - 705400928



**CAN-AM  
SPORTSWEAR  
& JERSEYS**  
P.59-61



**HOODIES ARE FOREVER.  
GEAR UP FOR LIFE WITH CAN-AM.**



**PERFORMANCE STYLED  
CROSS HELMETS & GOGGLES**  
P.62-64

**NEW ZIPPED HOODIE**

- Full-zip hooded sweatshirt.
  - Ribbed waistband and cuffs.
  - Can-Am print on hood with contrasting hood cords.
  - Screen printed logos.
- 60% Cotton, 40% Polyester  
286690  
S, M, L, XL, 2XL, 3XL  
Brick (33), Black (90)



**NEW IMPULSE HOODIE**

- Ribbed waistband and cuffs.
  - Contrasting inner hood.
  - Kangaroo front pocket.
  - Screen printed logos.
- 60% Cotton, 40% Polyester  
286689  
S, M, L, XL, 2XL, 3XL  
Khaki (05), Blue (80)



**TECHNICIAN SHIRT**

- Large X-Team embroidery at upper back.
  - Pleat at back center for ease of movement.
  - Chest pocket.
- 65% Polyester, 35% Cotton  
**286566** - S, M, L, XL, 2XL, 3XL  
 Charcoal Grey (07), Black (90)



**ORIGINAL TEE**

- 100% Cotton  
**286402** - S, M, L, XL, 2XL, 3XL - Heather Grey (27), Ice (38), Black (90)



**NEW MAVERICK TEE**

- 100% Cotton  
**454057** - S, M, L, XL, 2XL, 3XL - Sand (03), Blue (80)

**X-TEAM TEE**

- Print at sleeve and front.
- 100% Cotton  
**286618**  
 S, M, L, XL, 2XL, 3XL  
 White (01), Black (90)



**LADIES' X-TEAM TEE**

- V-neck.
- 95% Cotton, 5% Spandex  
**286567**  
 XS, S, M, L, XL  
 White (01) (01), Black (90)



**NEW CLASSIC CAP**

- Ultra comfortable, stretch, lightweight fabric.
  - Metal adjuster with BRP logo.
- 55% Cotton, 45% Polyester  
**286675**  
 One size  
 Orange (12), Black (90)



**NEW MAVERICK CAP**

- Plastic strap adjuster at back.
  - Embroidered logo.
- 447354**  
 One size  
 Khaki (05), Black (90)



**X-RACE JERSEY**

- Ultralight, quick-dry, antibacterial and moisture-wicking fabric.
  - Mesh fabric for maximum breathability.
- 100% Polyester

**286614** - S, M, L, XL, 2XL, 3XL - Orange (12), Blue (80)

- Extended back for coverage while riding.
- Non-fading sublimated graphics.
- Rib cuffs.



**TEAM JERSEY**

- Quick-dry, antibacterial moisture-wicking fabric.
  - Extended back for coverage while riding.
- 100% Polyester

**286553** - S, M, L, XL, 2XL, 3XL - Khaki (05), Yellow (10)

- Non-fading sublimated graphics.
- Rib cuffs.



**LADIES' TEAM JERSEY**

- Semi-fitted lady's cut.
  - Quick-dry, antibacterial, moisture-wicking fabric for maximum comfort.
- 90% Polyester, 10% Spandex

**286616** - XS, S, M, L, XL, 2XL - Pink (36), Teal (74)

- Mesh fabric for extra ventilation underarms and side seam.
- Rib cuff.



**NEW MUD JACKET**

- 100% waterproof PVC.
- Electronically-welded seams.
- Underarm and rear vent panels.
- 2 hand pockets.
- Elastic cuffs.
- Drawstring hood and hem.

**286676**  
 S, M, L, XL, 2XL  
 Clear (00), Matte Black (93)



**MUD PANTS**

- Oversized pants made of 100% waterproof PVC.
  - Electronically-welded seams.
  - Strategically placed ventilation.
  - Side openings at bottom leg.
- Polyvinyl Chloride (PVC)

**286128**  
 S, M, L, XL, 2XL  
 Clear (00), Matte Black (93)





**XP-R2** ULTRA LIGHTWEIGHT AND STRONG MULTI-DIRECTIONAL CARBON FIBER CONSTRUCTION WITH PREMIUM STYLE AND DETAILS.

**XP-R2 CARBON LIGHT BLAZE HELMET**

Shell: Carbon Fiber Composite  
447657  
XS, S, M, L, XL, 2XL, 3XL  
Orange (12)

DOT ECE22.05



**XP-R2 CARBON LIGHT HELMET**

Shell: Carbon Fiber Composite  
447656  
XS, S, M, L, XL, 2XL, 3XL  
Black (90)

DOT ECE22.05



**XP-R2 MORPHO KIT**

• For a perfect custom fit.  
• Left and right pads included.

447754 - XS, S, M, L, XL, 2XL, 3XL - Clear (00)



**ENDURO** DESIGNED FOR LONG RIDES AND HIGH ADVENTURE.

**NEW CAN-AM EX-2 ENDURO HELMET**

Shell: Polycarbonate Composite  
448466  
XS, S, M, L, XL, 2XL  
Black with graphics (94)

DOT ECE22.05



**XP-3** SUPERLIGHT CROSS-STYLE HELMET: FEATURE-PACKED FOR EXCEPTIONAL PERFORMANCE, PROTECTION AND COMFORT.

**XP-3 X-RACE HELMET**

• Durable multi-colored clear-coated graphics.

Shell: Fiberglass  
448395  
XS, S, M, L, XL, 2XL  
Orange (12), Blue (80)

DOT Snell ECE22.05



**XP-3 HELMET**

Shell: Fiberglass  
448253  
XS, S, M, L, XL, 2XL  
Matte Black (93)

DOT Snell



**XC-4** PREMIUM LOOK & STYLE.

**XC-4 MODERN HERITAGE HELMET**

Shell: Polycarbonate Composite  
448251  
XS, S, M, L, XL, 2XL  
White (01), Grey (09)

DOT Snell

**ECE VERSION**  
(Not available in NA)

448340  
XS, S, M, L, XL, 2XL  
White (01)

ECE22.05



**LADIES' XC-4 HELMET**

Shell: Polycarbonate Composite  
448397  
XS, S, M, L, XL, 2XL  
Pink (36)

DOT ECE22.05



**XC-4 HELMET**

Shell: Polycarbonate Composite  
448255  
XS, S, M, L, XL, 2XL  
Black (90)

DOT Snell



**DUST MASKS**

- Easily replaceable filters remove 99.9% of airborne dust, particles, pollen and odors.
- Made from soft yet durable neoprene material that fits snugly under helmets and goggles.
- XS/S fits most kids 12 and under, M/L fits most riders and XL/2XL fits larger frames (235+ lbs).
- Includes 2 replacement filters and a small storing pouch.

**CAN-AM ORIGIN DUST MASK**

447833  
XS/S, M/L, XL/2XL  
Black (90)



**CAN-AM VENTED DUST MASK**

448246  
XS/S, M/L, XL/2XL  
Grey (09)



**COMMUNICATION SYSTEM**

**SENA 20S BLUETOOTH COMM SYSTEM**

- Super-versatile, water-resistant multi-function Bluetooth communication, navigation and music system designed for outdoor and vehicle sound environment use.
- Driver-to-passenger and driver-to-driver communication at a range over 1.2 miles (2 km).
- Up to 12-hour talk and 10-day stand-by time on a single charge – permits simultaneous charge and play.
- 4-way conference, smartphone, intercom-to-phone connection, GPS and MP3 music playback via AVRCP operation, or easy-adjust manual operation with exclusive Jog Dial.
- Bluetooth technology allows for seamless connection with stereo headset, MP3 players, and smartphones.
- Voice-prompt feedback, clear and natural sound quality, individual volume control for each audio source, fully-integrated audio booster delivers optimal sound level – fully firmware-upgradable.
- Complete with integrated microphone, wired microphone, wired boom microphone, speakers, plus MP3, earbud, and GPS ports.

**Single Pack**

448207 - One size  
Black (90)

**Dual Pack**

448208 - One size  
Black (90)



\*Some models and accessories shown may not be available or homologated in your country. Contact your BRP dealer or local authorities for information.

Helmets shown are not available in Brasil. Contact your dealer for local helmets.

# GOGGLES

## NEW CAN-AM RACE SAND GOGGLES BY SCOTT

- Integrated custom painted frame and strap graphics.
- No Fog<sup>1</sup> anti-fog lens treatment.
- 100% UV protected grey Lexan<sup>1</sup> lens.
- Dust catcher vent foam.
- Multi-layer face foam.
- Durable anti-slip strap.
- Tear-off and roll-off compatible (sold separately).



448491  
One size  
Black (90)

## CAN-AM TRAIL GOGGLES BY SCOTT

- 100% UV protected clear Lexan lens.
- Hypoallergenic super-soft face foam.
- Durable anti-slip strap.
- Tear-off and roll-off compatible (sold separately).



447899  
One size  
White (01), Yellow (10), Black (90)



# JUNIOR

## NEW JUNIOR X CROSS CRUSH HELMET

- High-tech, lightweight and tough.
- Fully-adjustable aero-tuned peak.
- Moisture-wicking and breathable chin strap, liner and cheek pads.
- Ventilation system.
- Easily removable and washable liner and cheek pads.
- Provides maximum visibility.
- Fits all goggles.
- Strap grip to hold goggles strap in place.
- D.O.T. and EC certified.
- Breath deflector mask included.
- Available with clear-coated bold waterslide graphics.



ABS  
448506 · S, M, L · Black with graphics (94)

DOT ECE22.05

# GLOVES

## X-RACE GLOVES

- Air mesh panels and perforated palm for ventilation and mobility.
- Double Clarino<sup>1</sup> layer at palm and thumb for extra durability and comfort.
- Knuckle gussets for better mobility.
- Pre-curved design.
- Silicone at fingertips for added grip and control.
- Direct-injection details on back hand.
- Hook-and-loop wrist closure system to keep glove in place.



### MEN'S

Air Mesh, Spandex, Clarino

286561

S, M, L, XL, 2XL  
Charcoal Grey (07), Blue (80)

### LADIES'

35% Synthetic Leather, 30% Polyester, 15% Lycra, 10% Nylon, 10% Neoprene

286617

S, M, L, XL, 2XL  
White (01), Pink (36)



## TEAM GLOVES

- Spandex construction for flexibility.
- Chamude palm.
- Pre-curved design.
- Non-fading sublimated graphics.
- Easy slip-on/slip-off convenience.



Shell: Spandex, Chamude, Polyester

286554

S, M, L, XL, 2XL, 3XL  
Charcoal Grey (07)

## RANCH HEAVY DUTY GLOVES

- Full leather gloves.
- Durable double-layer suede palm.
- Pre-curved design.
- Elastic wrist for slip-on/slip-off convenience.



100% Cow Leather

286563

S, M, L, XL, 2XL, 3XL  
Beige (02)

# BAGS



## NEW CAN-AM SLAYER GEAR BAG BY OGIO

- Large main compartment with easy access to all gear.
- Large separated boot pocket.
- Zippered accessory pocket.
- Easy grab handles for transport.
- Detachable shoulder strap.
- Heavy-duty reinforced base
- Dimensions: 32" H x 16" W x 18" D ( 81 cm x 41 cm x 46 cm)

469294 · One size · Black (90)



## NEW CAN-AM URBAN BACKPACK BY OGIO

- Airport security friendly protective laptop compartment.
- Padded iPad<sup>™</sup>/tablet/e-reader pocket.
- Dual side water bottle/accessory holders.
- Fully adjustable ergonomic shoulder straps.
- Front pocket with two padded accessory compartments and slip pocket.
- Dimensions: 19.5" H x 13.5" W x 9.5" D (50 cm x 34 cm x 24 cm).

469293 · One size · Black (90)

## NEW CAN-AM JUNIOR TRAIL GOGGLES BY SCOTT

- Integrated custom painted frame and strap graphics.
- No Fog<sup>1</sup> anti-fog lens treatment.
- 100% Plastic UV protected clear Lexan<sup>1</sup> lens.
- Multi-layer face foam.
- Durable anti-slip strap.



448512  
One size  
Black (90)

# SIZING CHART 65

## HOW TO MEASURE

- For best results, have someone else take measurements.
- Measure body in underwear.
- Tape must be snug but not tight.
- If measurements fall between two sizes, order the larger size.

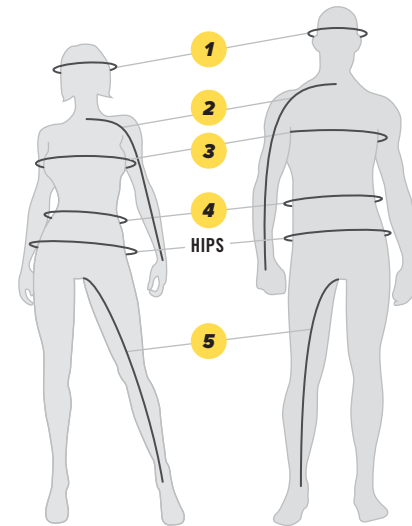

<b>1 HEAD</b>	Around your head, from the center of the forehead, above the ears and over the natural bump at the back of the head.
<b>2 ARM LENGTH</b>	Let the hands hang down on the side in a slightly bent position. Measure from the center of the back of your neck, along the length of your arm, to the wrist.
<b>3 CHEST/BUST</b>	Measure under your arms, around the fullest part of your chest.
<b>4 WAIST</b>	Measure around your natural waistline, keeping one finger between the tape and body.
<b>5 INSEAM</b>	Without shoes, from crotch to the floor.
<b>GLOVES</b>	Measure palm width.

## WHAT CODE REPRESENTS YOUR SIZE?

1. Find your size.
2. The corresponding code is **THE CODE** you use to complete the part number on your order.  
Example: 440227\_\_90 Size: M = Code "06", therefore 4402270690

SIZE	CODE	SIZE	CODE	SIZE	CODE	SIZE	CODE	SIZE	CODE	SIZE	CODE
One Size	00	XL	12	L/XL	73	11/12	56	10	30	32	38
XS	02	XLT	13	2	21	13/14	80	10.5	99	34	39
XS/S	90	2XL	14	3/4	79	14/16	50	11	31	36	40
S	04	3XL	16	5/6	52	4	23	12	32	38	41
M	06	4XL	18	6/8	48	6	25	13	33	40	42
MT	07	5XL	88	7/8	54	7	27	14	34	42	43
L	09	S/M	72	9/10	55	8	28	28	36	44	44
LT	10	M/L	91	10/12	49	9	29	30	37		

### MEN'S - 1,77 M - 1,83 M BODY MEASUREMENTS

	S	M	L	XL	2XL	3XL
CHEST	89-94	94-102	102-112	112-122	122-132	132-142
WAIST	74-79	79-86	86-97	97-107	107-117	117-127
HIPS	89-94	94-102	102-112	112-122	122-132	132-142
ARM LENGTH	79-81	81-84	84-86	86-89	89	89-91
INSEAM	80-81	81	81	81	81-82	82-83

### LADIES' - 1,64 M - 1,77 M

	XS	S	M	L	XL	2XL	3XL
CHEST	81-86	86-91	91-99	99-107	107-114	114-124	124-134
WAIST	61-66	66-71	71-76	76-86	86-94	94-104	104-114
HIPS	86-91	91-97	97-102	102-112	112-119	119-132	132-140
ARM LENGTH	79	79-81	81	81-83	83	83-86	86
INSEAM	76	76	76	76	76	76-77	77

### MEN'S GLOVES (MEASURE PALM WIDTH)

	S	M	L	XL	2XL	3XL
CM	7.5	8.5	9.5	10.5	11.5	14

### LADIES' GLOVES (MEASURE PALM WIDTH)

	S	M	L	XL	2XL
CM	6.8	7.5	8.3	9	11.5

### HELMETS

	XS	S	S/M	M	M/L	L	XL	2XL	3XL
HAT SIZE	6 3/8 - 6 3/4	6 7/8 - 7	7 1/8	7 1/8 - 7 1/4	7 1/4	7 3/8 - 7 1/2	7 5/8 - 7 3/4	7 7/8 - 8	8 1/8 - 8 1/4
HEAD (CM)	53-54	55-56	57	57-58	58	59-60	61-62	65-66	65-66

### JUNIOR HELMETS

	S	M	L
HAT SIZE	6 1/8 - 6 1/4	6 3/8 - 6 1/2	6 3/8 - 6 3/4
HEAD (CM)	49-50	51-52	53-54

# GENUINE BRP PARTS:

## THE RIGHT WAY TO PROTECT YOUR INVESTMENT.



# GENUINE MAINTENANCE PARTS

ENGINEERED TO DELIVER OPTIMUM PERFORMANCE AND EXTEND ENGINE LIFE ACROSS A WIDE RANGE OF OPERATING CONDITIONS.



### NGK SPARK PLUGS

• Ask your authorized Can-Am dealer which one fits your vehicle.



### OIL FILTER

420256188 • Fits all  
420256455 • Fits DS450

COMPLETE OIL CHANGE KIT ALSO AVAILABLE. (SEE PAGE 68)

### FUEL FILTER

(Not illustrated)

709000330 • Fits ATV 2011 and up

### O-RING (DRAIN PLUG)

(Not illustrated)

420552280

### O-RING (OIL FILTER COVER)

(Not illustrated)

420230920



### AIR FILTERS

- Prevent airborne contaminants from reaching your engine.
- Protect internal components against premature wear.
- Genuine BRP air filters ensure absolute compatibility and a perfect fit.
- Ask your authorized Can-Am dealer which one fits your vehicle.

OIL & MAINTENANCE PRODUCTS AT PAGE 69

# GENUINE REPLACEMENT PARTS 67

**DID YOU KNOW?**  
1 YEAR LIMITED WARRANTY ON BRP REPLACEMENT GENUINE PARTS



LEARN MORE ON PAGE 68

### PREMIUM DRIVE BELT

- High-performance design ideal for off-road use.
- BRP-specific calibration adjusted to best suit your Can-Am vehicle.
- Ask your authorized Can-Am dealer which one fits your vehicle.

422280360

715900024

### PERFORMANCE DRIVE BELT (100% PBO)

- High-performance belt technology designed for Side-by-side usage, but compatible on ATV for the most enthusiast drivers.
- 100% cutting-edge PBO high-tensile strength polymer fiber construction.
- Designed for high-temperature robustness and prolonged durability.

422280364

### PULLER/LOCKING TOOL / DRIVEN ADAPTOR

(Not illustrated)

- Spreads the secondary clutch open for easy belt replacement.
- Locks engine at TDC for maintenance tasks.

529036098

### CVT GASKET COVER

(Not illustrated)

G2 (Outlander MAX & Renegade)	G2L (Outlander & Outlander MAX 450)	G1 (Outlander & Outlander MAX 400)
420430126	420630292	420630290

### CV BOOT KITS

- Come with clamps and grease.
- Genuine BRP CV Boot Kits ensure absolute compatibility and a perfect fit.
- Ask your authorized Can-Am dealer which one fits your vehicle.



### PREMIUM HALF SHAFT

- Premium quality design ideal for off-road use.
- Includes CVs, Shaft and Boots with the best suited geometry for your Can-Am vehicle.
- Ask your authorized Can-Am dealer which one fits your vehicle.

NEW PRICE

### PERFORMANCE HALF SHAFT

- High-performance design ideal for off-road use with superior protection in mud riding.
- Includes CVs, shaft and Boots with the best suited geometry for your Can-Am vehicle.
- Ask your authorized Can-Am dealer which one fits your vehicle.

NEW PRICE

PRESERVE THE VALUE OF YOUR VEHICLE WITH REPLACEMENT PARTS YOU CAN RELY ON. ENGINEERED WITH HIGH PRECISION & TOLERANCES, NOTHING FITS A BRP VEHICLE BETTER THAN BRP GENUINE PARTS.



### METALLIC BRAKE PAD KIT

- Built strong to last long – heavy-duty construction stands up to hard braking.
- Designed to handle demanding riding conditions with challenging braking environments such as mud and sand.
- Created specifically for use with Can-Am ATV.

Fits: G2 2013 & up (except with 400 engine), G2 2012 with 800R or 1000 engine (except MAX models), G2L 2015 & up, G2S 2012 & up (except G2S 2012 with 500 engine)

Front Left  
715900248

Front and Rear Right  
715900249

### ORGANIC BRAKE PAD KIT

- Chosen as the standard OEM on Can-Am ATV for dry conditions.
- Provides excellent braking capacity with optimal efficiency, a great feel, and low noise.

Fits: G2 2013 & up (except with 400 engine), G2 2012 with 800R or 1000 engine (except MAX models), G2L 2015 & up, G2S 2012 & up (except G2S 2012 with 500 engine)

Front Left  
705601015

Front and Rear Right  
705601014



### TOUCH-UP PEN

- Ideal for do-it-yourself small paint repairs caused by rock chips and scratches on your bumpers, roll cage, a-arms, springs, beadlocks, etc.
- Genuine Can-Am color perfectly matches original paint for seamless coverage.
- For use on metal parts only.

529036363 • Can-Am Red  
529036362 • Manta Green

529000084 • Octane Blue  
529000095 • Sunburst Yellow



### YUASA<sup>+</sup> BATTERIES

- Top of the line models from the leading preferred original equipment battery supplier in North America.

18 Amps. Wet • (YTX20L-BS) • 410301203

19 Amps. Dry • (YB16CL-B) • 278001756

13 Amps. Wet • (YTX15L-BS) • 710000283



### MOTOCROSS<sup>+</sup> BATTERIES

- Complete line-up of economical and high-performance batteries.

- These 22 batteries cover more than 75% of the powersports market and meet Powersport Original Equipment Specifications.

- Ask your authorized Can-Am dealer which one fits your vehicle.

Renegade & Outlander 2004-2012

18 Amps. (YTX20L-BS) • 715900189

Traxter & Quest 1999-2005

19 Amps. (YB16CL-B) • 715900191



### CHOOSING THE RIGHT ONE CAN IMPACT POWER & PERFORMANCE.

A drive belt is the essential link between engine & drivetrain, so there's no overstating its importance for obtaining maximum power & efficiency. If your drive belt can't reach & maintain performance, then no amount fine-tuning or performance customization will make a difference.



Clutches & gears are calibrated for optimum ride-specific performance, so it only makes sense to use a specialized ride-specific drive belt too.

Our engineers always consider the heat generation & load conditions created by different riding styles. For example, the Maverick X3 produces higher drivetrain loads at hard throttle through dunes and requires a stiffer drive belt with high heat resistance. But a heavily loaded utility vehicle can also encounter high drivetrain loads.

However, the clutch calibration, engine, RPM, velocity, and work environment differ significantly necessitating a drive belt optimized for those conditions. That's why it's so important to choose the right drive belt.

Always make sure you match any replacement drive belt to the requirements of your BRP vehicle's make & year of manufacture. While third-party and BRP drive belts are identical in size & shape, ours were designed to deliver the highest levels of performance & longevity based upon your vehicle's specific end-use and calibration.

### WHAT MAKES OUR BELT STAND OUT?

One essential material stands among our drive belt components; aramid. Aramid, commonly used in the manufacture of drive belts, is a heat and abrasion resistant man-made fiber that improves the strength & durability of rubber.

- Top cog with special aramid fiber
- Adhesion rubber
- Specialized high-modulus aramid cord
- Compressive rubber with high-modulus PBO fiber
- Bottom cog with aramid fabric

### BRP BELT CONSTRUCTION VS. COMPETITORS

MATERIALS	BRAND A	BRAND A C12	BRAND B	BRP
Top Rubber Chopped Fiber	CR Aramid	CR Aramid	H-NBR Aramid/Cotton	CR Aramid
Upper Adhesion Rubber Chopped Fiber	CR	CR	H-NBR	CR
Cord	Aramid	Carbon	Aramid	Aramid
Lower Adhesion Rubber Chopped Fiber	CR	CR	H-NBR	CR
Bottom Rubber Chopped Fiber	CR Aramid	CR Aramid	H-NBR Aramid/Cotton	CR PBO Aramid
Bottom Fabric	Acrylic 1 ply	Acrylic 1 ply	CR Aramid/Cotton	Aramid/PET 1 ply

CR: Chloroprene Rubber

**MODULUS & TENSILE STRENGTH**

Based on BRP Dynamometer Testing

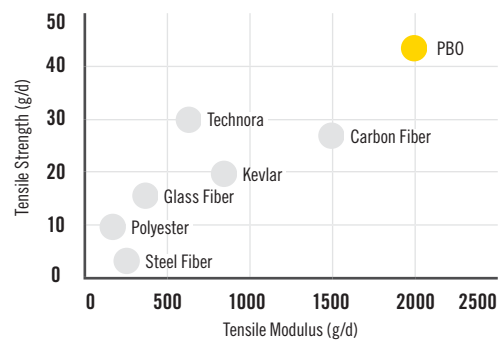

**DURABILITY COMPARISON**

When compared to BRP's Performance Drive Belt (100% PBO) (715900212).

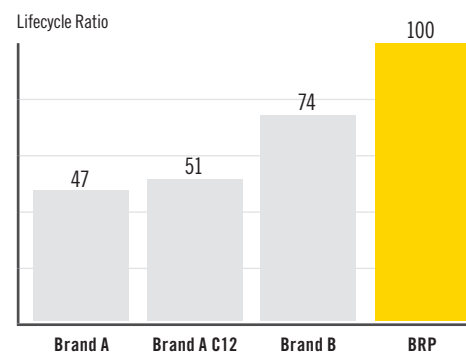

XPS IS A COMPLETE RANGE OF PERFORMANCE PRODUCTS DESIGNED TO PROTECT, ENHANCE, AND EXTEND THE LIFE OF YOUR BRP VEHICLE. EACH HAS BEEN RIGOROUSLY DEVELOPED, TESTED AND APPROVED. TAKE THE GUESSWORK OUT OF YOUR VEHICLE MAINTENANCE AND GET TRUE XPS PEACE-OF-MIND.

**KYLE CHANEY**  
PROFESSIONAL CAN-AM RACER,  
MULTI-TIME GNCC CHAMPION



### XPS ENGINE OILS



#### XPS 4-STROKE SYNTHETIC OIL (0W40)

- The best all-year-long choice for any BRP vehicle with a 4-stroke engine.
- Full-synthetic formula made from premium oil base stocks.
- Performs consistently throughout a broad temperature range.
- Tested and proven by BRP engineers to offer the best engine protection where its use is specified.
- Easy cold starting.
- Protects against corrosion and rust.
- Ambient temperature operating range +40°C/+104°F to -45°C/-49°F.

1 quart / 946 ml 779139      1 US gallon / 3.785 L 779140



#### XPS 4-STROKE SYNTHETIC BLEND OIL (5W40)

- The warm-weather choice for any BRP vehicle with a 4-stroke engine.
- Synthetic blend formula made from premium oil base stocks.
- Performs consistently throughout a broad temperature range.
- Tested and proven by BRP engineers to offer the best engine protection where its use is specified.
- Wet clutch compatible.
- Protects against corrosion and rust.
- Ambient temperature operating range +40°C/+104°F to -35°C/-31°F.

1 quart / 946 ml 779133      1 US gallon / 3.785 L 779134

### CONVENIENT DO-IT-YOURSELF KIT!



#### XPS OIL CHANGE KIT

- Ultra-convenient "all-in-one" oil change kit saves time and money.
- Includes XPS Synthetic or Synthetic Blend Oil, oil filter, o-rings and washer.

For Can-Am off-road vehicle with 450 cc or lower Rotax engine (except Rally & DS models)

703500902 - Synthetic Blend (5W40)  
703500903 - Synthetic (0W40)

For Can-Am off-road vehicle with 500 cc or higher Rotax engine (except Maverick X3, Traxter 1999-2005 & Quest models)

703500904 - Synthetic Blend (5W40)  
703500905 - Synthetic (0W40)

Some products shown may not be available or homologated in your country. Contact your BRP dealer for local details.



## NEW XPS PRODUCTS!

### XPS MAINTENANCE PRODUCTS

#### XPS SYNTHETIC GEAR OIL

- XPS Synthetic Gear Oil uses a unique combination of synthetic base stocks and additives that allow higher loads, superior shear stability and reduced oxidation compared to other synthetics and conventional API GL-5 gear oils.
- Its tremendous thermal stability and relatively constant viscosity give exceptional wear protection and superior performance for excellent low-temperature characteristics and improved gear protection at higher temperatures.
- Contains specific additives custom matched to provide the best performance of the BRP limited slip differentials.
- Offers added assurance during extended drain intervals.
- Exceeds API GL-5 specifications.
- Provides excellent protection in nearly all differentials, conventional and limited slip.
- Recommended for use in all Can-Am off-road vehicles.

779158 • 75W-90

779160 • 75W-140



#### XPS ANTI-CORROSIVE LUBRICANT

- A multipurpose lubricant that can also be used to prevent rust, corrosion and moisture intrusion.
- It contains extreme pressure additives that work as an all-around lubricant for just about anywhere lubrication is needed.

• 12 oz. / 340 g

779168



#### XPS SUSPENSION GREASE

- Designed to work specifically with the components found in Can-Am off-road vehicles suspensions.
- It is highly stable and offers optimal lubrication at both extreme cold and high temperatures while protecting suspension components from dirt and moisture, as well as corrosion under extreme washout conditions.

779163



#### XPS PRE-MIXED ANTIFREEZE/COOLANT

- XPS Antifreeze/Coolant contains the correct dilution and the necessary additives to prevent corrosion and inhibit cavitation in BRP cooling systems.
- Long-life, 5-year formula specially formulated for BRP vehicles.
- Superior heat transfer.
- Ideal replacement for vehicles that normally use a 2-year antifreeze/coolant (green).
- 5 years (orange) - 1 quart / 946 ml

779150



### XPS MAINTENANCE PRODUCTS

#### XPS FUEL STABILIZER

- Ethanol-compatible and will stabilize fuel in your tank to keep it from breaking down and causing hard starting, throttle hesitation and poor run quality.
- Ethanol attracts moisture, and this product contains powerful anti-corrosion additives to protect fuel system components.
- Prevents problems associated with E10 fuels.

• 8 oz. / 240 ml

779171



#### NEW XPS CARBURETOR CLEANER

- Complete fuel treatment specially formulated to prevent small engine problems caused by Ethanol-blended fuels.
- It removes fuel system gum and varnish that may have accumulated during storage, stabilizes fuel against breakdown for 12 months or more, and adds corrosion protection from moisture for short- and long-term storage.
- It also helps restore throttle response and easy starting.
- It can be used periodically to maintain fuel system integrity, keep carburetor jets clean, and also combat moisture problems caused by Ethanol-blended fuels to keep ferrous and soft metal parts clean and free of corrosion.

• 12 oz. / 355 ml

779172



#### XPS CARBON FREE FUEL TREATMENT

- Combination of a fuel treatment and a fuel system cleaner that can be used periodically to restore lost starting or throttle performance, as well as maintain fuel system integrity and keep internal engine parts clean.
- It treats fuel for storage and addresses the moisture problems inherent in today's Ethanol-blended fuels, keeping ferrous and soft metal parts clean and free of corrosion.
- Uses patented, state-of-the-art additives.
- Cleans valves, sticky rings and combustion chamber.

• 12 oz. / 355 ml

779169



#### XPS BRAKE FLUID

- Meets or exceeds all DOT3 and DOT4 brake fluid requirements.
- High-temperature formula resists fade, and also conditions seals and o-rings in braking system.

• 12 oz. / 355 ml

779151



#### NEW XPS RACING BRAKE FLUID

- Exceeds DOT4 brake fluid requirements for extreme conditions and competition use.
- Extreme, 579-degree boiling point temperature is ideal for high-demand competition conditions to combat brake fade.

• 12 oz. / 355 ml

779152



#### NEW XPS HIGH PERFORMANCE SUSPENSION FLUID

- A synthetic, fade-free formula for servicing FOX® shocks.
- Specially formulated for high demand or racing application.
- Ultra high VI shock oil.
- Engineered viscosity for optimized performance with FOX® shocks valving.

• 12 oz. / 355 ml

779154



### XPS CLEANERS

#### XPS SPRAY CLEANER & POLISH

- Features a water-based formula safe for all plastics.
- Rinse-free spray-on/buff-off formula.
- Protects against UV and ozone damage and resists dirt accumulation.
- It can be used on painted surfaces, fiberglass, chrome and plastics.

• 12 oz. / 340 g

219702844



#### XPS OFF-ROAD WASH

- A biodegradable non-toxic cleaner that removes mud and dried-on dirt from your off-road vehicle.
- Whether grimy from the track, the woods or the fields, this cleaner will leave your off-road vehicle sparkling.
- When used as directed, XPS Wash is safe for all off-road vehicle finishes.

• 32 oz. / 946 ml

219701702



#### XPS BRAKES & PARTS CLEANER

- A concentrated blend of solvents with a powerful blasting spray that effectively removes grease, grime, brake fluid and other contaminants from brake components and metal parts.
- Evaporates instantly and completely, leaving no residue to hinder performance.
- Contains no ozone depleters.

• 14 oz. / 397 g

219701776



#### XPS MICROFIBER TOWELS

- Made from extremely fine fibers whose soft surfaces have been perfected for use in drying and polishing.
- Won't harm delicate surfaces.
- Holds up to seven times its weight in water.
- Machine washable and reusable.

• Pack of 2.

219701759



# CHART NEW TERRITORY

**You know who you are.**

You are among the few who dare to go off the beaten path. You are all about performance that goes beyond belief. Which is why you need products that go beyond expectations. XPS oils and lubricants answer the call. Specifically designed to optimize high performance, reliability and long engine life for Can-Am off-road vehicles, XPS was developed right alongside Rotax engines. Passing the highest levels of testing for an unparalleled experience in all conditions. Begin your journey at your BRP dealer.



**Kyle Chaney**  
Professional Can-Am Racer,  
Multi-time GNCC Champion



Some products shown may not be available or homologated in your country. Contact your BRP dealer for local details.



**ski-doo LYNX SEA-DOO EVINRUDE ROTAX Can-am**